

# IRON<sup>BALTIC</sup>

*Helping to make your vehicle all it can be!*

## ATV & UTV ACCESSORIES



**QUADIVATOR** INC.



**ECO**

# IRON BALTIC

Follow us   

Iron Baltic Ltd is active in producing and supplying ATV / UTV accessories. Iron Baltic's main products are skid plates, snow plows and coupling devices for ATVs and UTVs. Total of 80% of the products the company offers are Iron Baltic own manufactured products, while a further 20% of them are imported, supplied elsewhere. Iron Baltic's company vision and objective is to offer wide range of accessories and coupling devices for ATVs / UTVs and promote the use of ATVs / UTVs for just about any operation possible.



IB products are designed by keeping in mind the specific needs of Northern European countries, they are well known for their excellent quality and ingenious solutions. Our main products include skid plates, snow plows, and various coupling devices.



ECO - products are imported, improved, and packaged by Iron Baltic. A more affordable line of products for a budget conscious user. The main products in this area include various forms of coupling device, plus luggage and cargo baskets.



Quadivator - innovative ATV and UTV products made in Canada. Products are designed for simple installation and ease of use. Quadivator products include agricultural implements as cultivators, tandem discs, harrows, snow blowers, rakes and mowers. Iron Baltic have exclusive sales rights for Quadivator products in Europe.



# CONTENTS

## SKID PLATES

ALUMINIUM SKID PLATES	2
PLASTIC SKID PLATES	8

## WINTER

MID-MOUNT PLOW SYSTEM	14
FRONT-MOUNT PLOW SYSTEM	16
UTV FRONT-MOUNT PLOW SYSTEM	18
MID-MOUNT V-PLOW SYSTEM G2	28
FRONT-MOUNT V-PLOW SYSTEM G2	30
PLOW BUCKETS	34
2-IN-1 MODULAR PLOW BUCKET	36
SAND SPREADER G2-500 PRO	38
UNIVERSAL SPREADER / SEEDER	39
ROTARY BROOM	40
SNOW BLOWER	42
SKI TRACK MAKER	44
CLASSIC TRACK SETTER	46
CARGO SLED	47
SKI SLED	48
TIMBER SLED	49

## FARMING

TRAILER IB-165	50
TRAILER OFFROAD 500	52
TRAILER OFFROAD PRO 1200	54
TRAILER ECO 1500 3-WAY	56
FLAIL MOWER	58
BALE TRAILER	60
SILO & HAY BALE TRAILER	61
SWEEPER COLLECTOR	62
RIDING ARENA LEVELER	64
RECEIVER HITCH SYSTEM	66
DRAG HARROW	70
LEVELER	71
FLIP OVER DISC	72
LANDSCAPE RAKE	73
TWO-BOTTOM PLOW	74
LAND ROLLER	76
GRADER / ROAD SCRAPER	78

## FORESTRY

TIMBER TRAILER IB 1200	80
TIMBER TRAILER COMBO 1000	84
LOG HAULER	88
WOOD CHIPPER G1	90
WOOD CHIPPER G2	91
LEAF VACUUM	92

## ACCESSORIES

HYDRAULIC POWER UNIT	94
ELECTRO-HYDRAULIC CYLINDER	96
HITCH RECEIVER RACK	98
CHAINSAW HOLDER	99
QUICK RELEASE CLAMPS	100
ECCENTRIC CLAMP	102
WINCH ROPE FAIRLEAD	102
LOADING RAMPS	102
BED WALL EXTENDERS	103
FRONT PROTECTIONS	104
CAN-AM G2 RENEGADE	
LUGGAGE RACK	104
EQUIPMENT BOX	105
FRONT AND REAR BOXES	106

## ADAPTERS

MODEL SPECIFIC MOUNTING KITS	107
------------------------------	-----



# ALUMINIUM SKID PLATES



Material	Corrosion resistant, brushed marine aluminium
Thickness	4mm
Info	Full protection of bottom and the front part of the ATV Openings for mud draining and washing Holes for oil changing Holes for plow mounting kits Fasteners and instructions are enclosed

Iron Baltic aluminium skid plate kits are made from marine grade aluminium, which is the hardest aluminium that can still be mechanically processed. The aluminium is shaped using CNC cutting, the sides are then CNC bent, and the corners of the bent sides TIG welded. The outcome is a structurally rigid skid plate that is strong and durable even in extreme conditions. Iron Baltic skid plate kits come complete with arm guards and full mounting hardware required for installation.

Access	Code
AX 700	02.11400
AX 600/800	02.25300
Arctic Cat	Code
500/550/700	02.9400
550/700 Limited	02.11800
Alterra 550 / 700	02.20700
1000 XT	02.2000
TRV 500 / 550 / 700 / TRV Alterra	02.6600
TRV 1000 / TRV 1000 Alterra	02.11200
Wildcat (-2016)	02.9800



The design of the Arctic Cat skid plates is based on the 2014 model and might not be suitable on newer models (except for the Alterra).



BRP Can-Am	Code
Outlander G1	02.6300
Outlander G1 MAX	02.6000
Outlander G2 L	02.15800
Outlander G2 L MAX	02.16400
Outlander G2 (2012-2016)	02.8400
Outlander G2 MAX (2013-2016)	02.10000
Outlander G2 450/570 L (2017+)	02.15800
Outlander G2 450/570 L MAX (2017+)	02.16400
Outlander G2 (2017-2018) *	02.18800
Outlander G2 (2019+) *	02.23100
Outlander G2 MAX (2017-2018) *	02.19200
Outlander G2 MAX (2019+) *	02.23600
Outlander 6x6 (-2016)	02.20300
Outlander 6x6 (2017-2018)	02.21100
Outlander 6x6 (2019+)	02.24800
Outlander 6x6 MAX (2017-2018)	02.22900
Outlander 6x6 MAX (2019+)	02.25100
Outlander 6x6 450 T (2020+)	02.26200
Outlander X MR 650/800/850 (-2016)	02.8400
Outlander X MR 650/850 (2017-2018)	02.18800
Outlander X MR 650/850 (2019+)	02.23100
Outlander X MR 1000 (-2016)	02.10000
Outlander X MR 1000 (2017-2018)	02.19200
Outlander X MR 1000 (2019+)	02.23600
Renegade G1	02.6900
Renegade G2 (-2016)	02.8200
Renegade G2 (2017-2018)	02.20100
Renegade G2 (2019+)	02.23800
Renegade X MR (-2016)	02.18200
Renegade X MR (2017-2018)	02.19000
Renegade X MR (2019+)	02.23400
Commander (-2014)	02.8900
Maverick (-2014)	02.12200
Traxter/Defender	02.21300
Cectek	Code
500 Gladiator	02.2200
500 Quadrift	02.2200
500 KingCobra	02.3020



\* Except for the "L" series equipment (without front bumper).

CFMOTO	Code
CFORCE 450/520-S	02.17000
CFORCE 450/520-L	02.17200
500-2	02.1080
500-2A	02.1070
CFORCE 500/600-S (X5/X6)	02.6400
CFORCE 500/600-L (X5A/X6A)	02.6100
CFORCE 550/600	02.15000
CFORCE 625	02.27100
CFORCE 625 Touring	02.25700
CFORCE 800/820 (X8)	02.8700
CFORCE 800 LUX (X8 LUX)	02.9200
CFORCE 850/1000	02.20900
CFORCE 1000 Overland	02.20900
ZFORCE 550 EX (Z5 EX)	02.13600
ZFORCE 600 (Z6)	02.5700
ZFORCE 600 EX (Z6 EX)	02.14100
ZFORCE 800 EX (Z8 EX)	02.13600
ZFORCE 1000	02.13600
ZFORCE 950/1000 Sport	02.26100
UFORCE 550	02.10700
UFORCE 600	02.28000
UFORCE 800	02.10700
UFORCE 1000	02.24600
Dinli	Code
600 Prime	02.4400
DL 700	02.1980
DL 702	02.4400
DL 702L	02.7200
DL 704	02.2500
DL 703	02.6500
GOES	Code
520	02.7900
520 MAX	02.7800
525/625	02.5100
525/625 MAX	02.5000
725	02.14300
Cobalt/Iron	02.19800
Cobalt/Iron MAX	02.19600

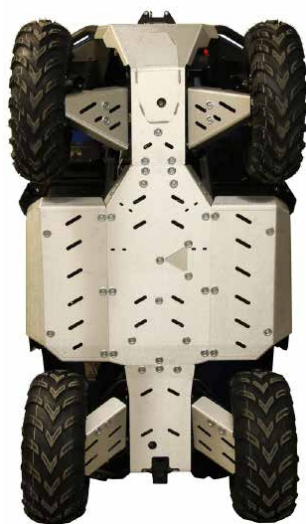

Hisun	Code
400	02.1300
700	02.8600
Tactic 550/750 2-UP	02.21600
Honda	Code
TRX 420 FA (-2013)	02.3100
TRX 420 FE/FM (-2013)	02.1200
TRX 420 FA/FE/FM (2014+)	02.13000
TRX 420 FA6 (IRS)	02.16000
TRX 500 FA	02.900
TRX 500 FA (IRS)	02.16000
TRX 500 FE (-2011)	02.900
TRX 500 FE (2012-2013)	02.7400
TRX 500 FE (2014+)	02.13400
TRX 520 FA (IRS) (2019+)	02.16000
TRX 650	02.1010
TRX 680 (-2014)	02.1010
TRX 680 (2015+)	02.16200
Kawasaki	Code
KVF 650 Rigid	02.450
KVF 650/750 BruteForce	02.400
Keeway (Leone Mastiff)	Code
XY 500-S	02.10300
Kymco	Code
MXU 500	02.1180
MXU 700 (-2019)	02.22000
MXU 700 (2020+)	02.27300
Linhai	Code
400	02.3550
400 IRS	02.5250
500	02.24200
550	02.12000
M550L	02.25500
600	02.12700
ODES	Code
ODES 800	02.21800
ODES 650/850/1000 S (2021+)	02.28300
ODES 650/850/1000 L (2021+)	02.28100

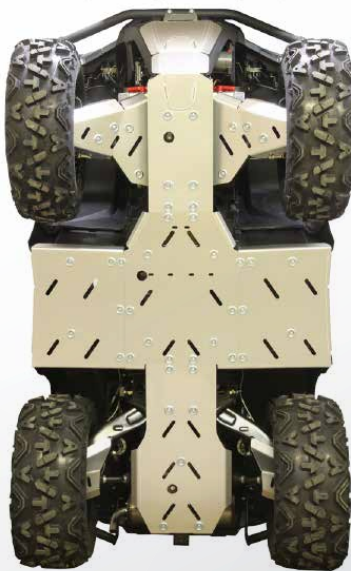

Polaris	Code
ACE 325/570	02.14500
Sportsman 400 (2011+)	02.5600
Sportsman 450/570/ETX	02.12500
Sportsman 500 (-2010)	02.2300
Sportsman 500 (2011+)	02.5600
Sportsman 550	02.1520
Sportsman 570 (2021+)	02.26900
Sportsman 570 SP (2021+)	02.26700
Sportsman 800 (-2010)	02.1400
Sportsman 800 (2011+)	02.5600
Sportsman 850 (-2014)	02.1520
Sportsman 850 (2015+)	02.16600
Sportsman 1000 (-2016)	02.16600
Sportsman 1000 (2017+)	02.19400
Sportsman 1000 S (2020+)	02.25900
Sportsman X2 800	02.1600
Sportsman Touring 550	02.5500
Sportsman Touring 570 / X2	02.13900
Sportsman Touring 850 (-2014)	02.5500
Sportsman Touring 850 (2015+)	02.18000
Sportsman Touring 1000 (-2017)	02.18000
Sportsman Touring 1000 (2018+)	02.24000
Scrambler 850/1000 (-2014)	02.10200
Scrambler 850/1000 (2015+)	02.16800
Scrambler 1000 S (2020+)	02.26400
RZR 570	02.17800
RZR 800	02.4000
RZR 800 S	02.4200
RZR 900 XP (-2014)	02.7500
RZR 1000 XP	02.14200
RZR 1000 XP Turbo	02.14200
RZR PRO XP	02.26600
Big Boss 570	02.18500
Big Boss 800	02.9600
Ranger 400/EV	02.7000
Ranger 570 (-2014)	02.12900
Ranger 570 (2015+)	02.18400
Ranger 800 HO	02.8000
Ranger 900 XP	02.12300
Ranger 900 Diesel	02.8000
Ranger 1000 Diesel (-2018)	02.12300
Ranger 1000 XP (2018-2020)	02.23300
Polaris General 1000	02.20000





Segway	Code
Snarler AT6 L	02.27500
Snarler AT6 S	02.27700
SMC	Code
J-MAX 700	02.15200
J-MAX 700L (T3)	02.15400
MBX 700	02.15600
Suzuki	Code
Eiger 400	02.200
KingQuad 450/500/700/750 (-2018)	02.800
KingQuad 500/750AXi (EPS)	02.4800
KingQuad 500/750AXi 2019+	02.4800
SYM	Code
600	02.1190
TGB	Code
425 Blade	02.4600
550 Blade	02.14800
600 Blade	02.22200
600 LT Blade	02.22400
1000 Blade	02.20500
Trapper	Code
Trapper 550/750	02.21600
Yamaha	Code
Grizzly 450 (2006-2008)	02.1000
Grizzly 450 (2009-2010) mitte EPS	02.3120
Grizzly 550	02.700
Grizzly 660	02.500
Grizzly 700 (-2013)	02.700
Grizzly 700 (2014-2015)	02.13100
Grizzly 700 (2016+)	02.17400
Kodiak 700	02.17600
Kodiak 450 (2017+)	02.21400
Wolverine 700	02.22800





## PLASTIC SKID PLATES



Material	Plastic (PE HWU)
Thickness	10mm
Info	<p>Full protection of bottom and front part of the ATV.          Openings for mud draining and washing.          Holes for oil changing.          Holes for plow mounting kits.          Fasteners and instructions are enclosed.</p>

Iron Baltic plastic skid plate kits are made from high density polyethylene HDPE (PE-HWU), which does not dent like aluminium, has excellent sliding properties and high chemical and UV resistance. The material remains very tough even at low temperatures (even at  $-50^{\circ}\text{C}$  /  $-58^{\circ}\text{F}$ ) but is still flexible enough not to deform and regain its shape after an impact. Plastic skid plates are structurally rigid and durable with low friction properties offering easy and safe operations even in extreme conditions. Iron Baltic skid plate kits come complete with arm guards and full mounting hardware required for installation.

Access	Code
AX 600/700/800 U (short models)	02.25400
Arctic Cat	Code
500/550/700	02.9500
550/700 Limited	02.11900
Alterra 550 / 700	02.20800
1000 XT	02.9100
TRV 500 / 550 / 700	02.11100
TRV 1000 / TRV	02.11300

The design of the Arctic Cat skid plates is based on the 2014 model and might not be suitable on newer models (except for the Alterra).



BRP Can-Am	Code
Outlander G1	02.13800
Outlander G1 MAX	02.13700
Outlander G2 L	02.15900
Outlander G2 L MAX	02.16500
Outlander G2 (-2016)	02.8500
Outlander G2 MAX (-2016)	02.10100
Outlander G2 450/570 (2017+)	02.15900
Outlander G2 450/570 MAX (2017+)	02.16500
Outlander G2 (2017-2018) *	02.18900
Outlander G2 (2019+) *	02.23200
Outlander G2 MAX (2017-2018) *	02.19300
Outlander G2 MAX (2019+) *	02.23700
Outlander 6x6 (-2016)	02.20400
Outlander 6x6 (2017-2018)	02.21200
Outlander 6x6 (2019+)	02.24900
Outlander 6x6 MAX (2017-2018)	02.23000
Outlander 6x6 MAX (2019+)	02.25200
Outlander 6x6 450 T (2020+)	02.26300
Outlander X MR 650/800/850 (-2016)	02.8500
Outlander X MR 650/850 (2017-2018)	02.18900
Outlander X MR 650/850 (2019+)	02.23200
Outlander X MR 1000 (-2016)	02.10100
Outlander X MR 1000 (2017-2018)	02.19300
Outlander X MR 1000 (2019+)	02.23700
Renegade G1	02.1610
Renegade G2 (-2016)	02.8300
Renegade G2 (2017-2018)	02.20200
Renegade G2 (2019+)	02.23900
Renegade X MR (-2016)	02.18300
Renegade X MR (2017-2018)	02.19100
Renegade X MR (2019+)	02.23500
Traxter/Defender	02.21300

\* Except for the "L" series equipment (without front bumper).



Ceatek	Code
500 Gladiator	02.4700
500 Quadrift	02.4700
500 KingCobra	02.9000
CFMOTO	Code
CFORCE 450/520-S	02.17100
CFORCE 450/520-L	02.17300
500-2	02.1140
500-2A	02.1130
CFORCE X5/X6	02.2850
CFORCE X5A/X6A	02.2800
CFORCE 550/600	02.15100
CFORCE 625	02.27200
CFORCE 625 Touring	02.25800
CFORCE 800/820 (X8)	02.8800
CFORCE 800 LUX (X8 LUX)	02.9300
CFORCE 850/1000	02.21000
CFORCE 1000 Overland	02.21000
ZFORCE 550 EX (Z5 EX)	02.13600
ZFORCE 600 (Z6)	02.5900
ZFORCE 600 EX (Z6 EX)	02.14100
ZFORCE 800 EX (Z8 EX)	02.13600
ZFORCE 1000	02.13600
ZFORCE 950/1000 Sport	02.26100
UFORCE 550	02.10800
UFORCE 600	02.28000
UFORCE 800	02.10800
UFORCE 1000	02.24500
Dinli	Code
600 Prime	02.4500
DL 700	02.3150
DL 702	02.4500
DL 703	02.7300
GOES	Code
520	02.10500
520 MAX	02.10900
525/625	02.6200
525/625 MAX	02.11000
725	02.14400
Cobalt/Iron	02.19900
Cobalt/Iron MAX	02.19700





<b>Hisun</b>	<b>Code</b>
Tactic 550/750 2-UP	02.21700
<b>Honda</b>	<b>Code</b>
TRX 420 FA (-2013)	02.3400
TRX 420 FE/FM (-2013)	02.1800
TRX 420 FA/FE/FM (2014+)	02.13300
TRX 420 FA6 (IRS)	02.16100
TRX 500 FA	02.1120
TRX 500 FA (IRS)	02.16100
TRX 500 FE (-2011)	02.1120
TRX 500 FE (2012-2013)	02.7700
TRX 500 FE (2014+)	02.13500
TRX 520 FA (IRS) (2019+)	02.16100
TRX 650	02.1110
TRX 680 (-2014)	02.1110
TRX 680 (2015+)	02.16300
<b>John Deere</b>	<b>Code</b>
Gator XUV865	02.24700
<b>Kawasaki</b>	<b>Code</b>
KVF 650 Rigid	02.480
KVF 650/750 BruteForce	02.1150
<b>Keeway (Leone Mastiff)</b>	<b>Code</b>
XY 500-S	02.10600
<b>Kymco</b>	<b>Code</b>
MXU 500	02.1850
MXU 700	02.22100
MXU 700 (2020+)	02.27400
<b>Linhai</b>	<b>Code</b>
400	02.3500
400 IRS	02.5200
500	02.24300
550	02.12100
M550L	02.25600
600	02.12800
<b>ODES</b>	<b>Code</b>
ODES 800	02.21900
ODES 650/850/1000S (2021+)	02.28400
ODES 650/850/1000L (2021+)	02.28200

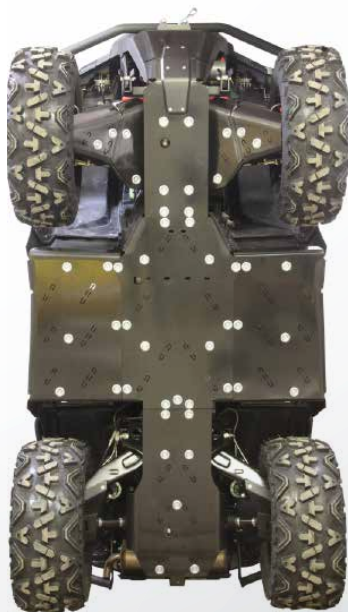

Polaris	Code
ACE 325/570	02.14600
Sportsman 400 (2011+)	02.5800
Sportsman 450/570/ETX/SP (-2020)	02.12600
Sportsman 500 (-2010)	02.2350
Sportsman 500 (2011+)	02.5800
Sportsman 550	02.1540
Sportsman 570 (2021+)	02.27000
Sportsman 570 SP (2021+)	02.26800
Sportsman 800 (-2010)	02.1410
Sportsman 800 (2011+)	02.5800
Sportsman 850 (-2014)	02.1540
Sportsman 850 (2015+)	02.16700
Sportsman 1000 (-2016)	02.16700
Sportsman 1000 (2017+)	02.19500
Sportsman 1000 S (2020+)	02.26000
Sportsman X2 800	02.1650
Sportsman Touring 550	02.5400
Sportsman Touring 570 / X2	02.14000
Sportsman Touring 850 (-2014)	02.5400
Sportsman Touring 850 (2015+)	02.18100
Sportsman Touring 1000 (-2017)	02.18100
Sportsman Touring 1000 (2018+)	02.24100
Scrambler 850/1000 (-2014)	02.10400
Scrambler 850/1000 (2015+)	02.16900
Scrambler 1000 S (2020+)	02.26500
RZR 570	02.17800
RZR 800	02.4100
RZR 800 S	02.4300
RZR 900 XP (-2014)	02.7600
RZR 1000 XP	02.14200
RZR 1000 XP Turbo	02.14200
RZR 900S / 1000S	02.25000
RZR PRO XP	02.26600
Big Boss 570	02.18600
Big Boss 800	02.9700
Ranger 400/EV	02.7100
Ranger 570 (-2014)	02.12900
Ranger 570 (2015+)	02.18400
Ranger 900 XP	02.12400
Ranger 900 Diesel	02.8100
Ranger 1000 Diesel (-2018)	02.12400



Ranger 1000 (2018-2020)	02.23300
Ranger 1000 (2021+)	02.27900
Polaris General 1000	02.20000
<b>Segway</b>	<b>Code</b>
Snarler AT6 L	02.27600
Snarler AT6 S	02.27800
<b>SMC</b>	<b>Code</b>
J-MAX 700	02.15300
J-MAX 700L (T3)	02.15500
MBX 700	02.15700
<b>Suzuki</b>	<b>Code</b>
KingQuad 450/500/700/750 (-2018)	02.1160
KingQuad 500/750AXi (EPS)	02.4900
KingQuad 500/750AXi 2019+	02.4900
<b>SYM</b>	<b>Code</b>
600	02.1890
<b>TGB</b>	<b>Code</b>
550 Blade	02.14900
600 Blade	02.22300
600 LT Blade	02.22500
600 LTX Blade	02.22500
1000 Blade	02.20600
1000 LTX Blade	02.20600
<b>Trapper</b>	<b>Code</b>
Trapper 550/750	02.21700
<b>Yamaha</b>	<b>Code</b>
Grizzly 450 (2006-2008)	02.1960
Grizzly 450 (2009-2010) not EPS	02.3010
Grizzly 550	02.1170
Grizzly 660	02.2900
Grizzly 700 (-2013)	02.1170
Grizzly 700 (2014-2015)	02.13200
Grizzly 700 (2016+)	02.17500
Kodiak 700	02.17700
Kodiak 450 (2017+)	02.21500





## MID-MOUNT PLOW SYSTEM



Mid-mount plow system for snow removal or soil planning. The plow mounts under the vehicle with a model specific or universal mounting adapter. The mid-mount plow system is available in many configurations - with different type and size of plow blades or as a push broom instead. Wide selection of optional accessories are available for the mid-mount plow - side extensions, marker antennas, rubber lips for the plow blades and hydraulic or electro-hydraulic control and movement kits for the plow system, see plow accessories on page 22–24.

- 5-position adjustable working position
- Spring-loaded resistance absorber
- Adjustable working angle
- Sliding shoes for height adjustment





Push tubes	Code
Mid-mount standard	04.200
Mid-mount / tracks fitted machines	04.700
Standard blades	Code
Blade 1280mm	04.100
Blade 1500mm	04.300
Blade 1800mm	04.800
Plastic blades	Code
Plastic blade 1520mm	20.7700
High-Throw blades	Code
High-Throw blade 1500mm	20.7200
High-Throw blade 1800mm	20.7300
Push brooms	Code
Push broom 1500mm	20.1000
Adapters	Code
Universal mid-mount adapter	03.4000

Model specific adapters seen in the “Mid-mount adapters” table, page 107–115.

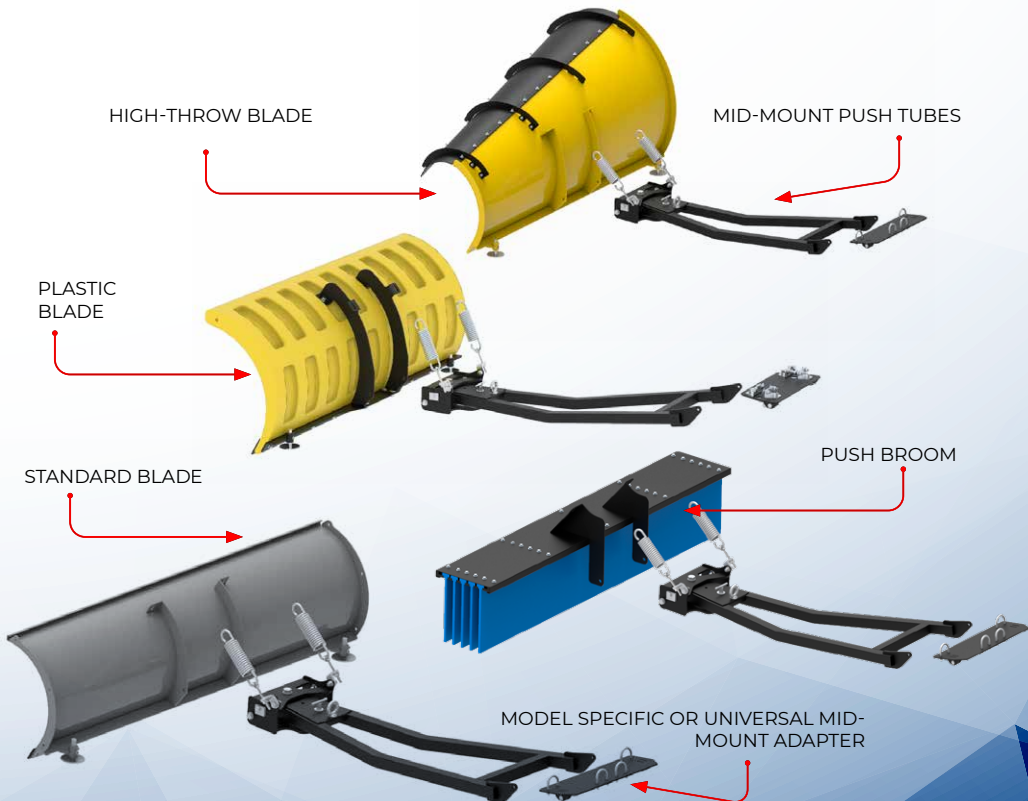



## FRONT-MOUNT PLOW SYSTEM



Front-mount plow system for snow removal or soil planning. The plow mounts with a model specific adapter on front of the vehicle using a self-locking quick attach system. Front-mount system completes with different type and size of plow blades, or a push broom. With variety of optional accessories available, it can also be turned into a bucket or use with hydraulic or electro-hydraulic control and movement kits, see plow accessories on page 22-24

- 5-position adjustable working position
- Spring-loaded resistance absorber
- Adjustable working angle
- Sliding soles for height adjustment
- Self-locking fastening system (quick and easy installation)
- Does not affect vehicle clearance
- High plow lift



<b>Push tubes</b>	<b>Code</b>
Front-mount, standard	20.6200
Front-mount, narrow	20.6400
<b>Standard blades</b>	<b>Code</b>
Blade 1280mm	04.100
Blade 1500mm	04.300
<b>Plastic blades</b>	<b>Code</b>
Plastic blade 1520mm	20.7700
<b>High-Throw blades</b>	<b>Code</b>
High-Throw blade 1500mm	20.7200
<b>Push brooms</b>	<b>Code</b>
Push broom 1500mm	20.1000
<b>Adapters</b>	<b>Code</b>

Fitment information on model specific adapter and matching push tube version (standard/narrow), find from the table "front mounting adapters" on page 107-115.





## UTV FRONT-MOUNT PLOW SYSTEM



A front-mounted plow system with reinforced coupling / locking mechanism for mounting the equipment with a model specific adapter on UTV-s or other larger side-by-side vehicles. UTV front mount plow system completes with different size of standard plow blades and high-throw plow blades or a push broom. Additional accessories such as blade extensions or rubber lips, bucket conversion kits and hydraulic or electro-hydraulic control and movement kits are available, see plow accessories on page 22–24.

- Reinforced construction
- 5-position adjustable working position
- Spring-loaded resistance absorber
- Adjustable working angle
- Sliding shoes for height adjustment
- Self-locking fastening system (quick and easy installation)
- Does not affect vehicle clearance
- High plow lift

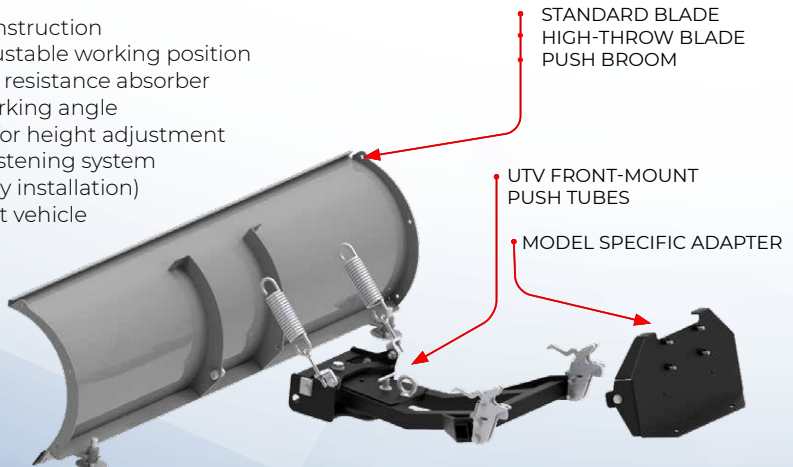



<b>Push tubes</b>	<b>Code</b>
UTV Front-mount	20.7400
<b>Standard blades</b>	<b>Code</b>
Blade 1280mm	04.100
Blade 1500mm	04.300
Blade 1800mm	04.800
<b>Plastic blades</b>	<b>Code</b>
Plastic blade 1520mm	20.7700
<b>High-throw blades</b>	<b>Code</b>
High-throw blade 1500mm	20.7200
High-throw blade 1800mm	20.7300
<b>Push brooms</b>	<b>Code</b>
Push broom 1500mm	20.1000
<b>Adapters</b>	<b>Code</b>
CFMOTO / UFORCE 600	03.12700
CFMOTO / UFORCE 1000	03.10600
CFMOTO / ZFORCE 950/1000	03.11800
CORVUS / Terrain DX4 (-2020)	03.12100
CORVUS / Terrain DX4 (2021+)	03.13000
POLARIS GENERAL	03.7900
POLARIS RZR 900S / 1000S	03.7900
POLARIS RZR 900 XP	03.7000
POLARIS RANGER 400/570/800/900D/EV	03.7000
POLARIS RANGER 1000 (2018+)	03.9800



## STANDARD PLOW BLADES

The standard construction plow blades are suitable for snow removal or soil planning. Optional accessories include a blade extension, a bucket attachment, or a rubber blade.

Working height 450mm

Working width 1280mm / 1500mm / 1800mm

Standard blades	Code
Blade 1280mm	04.100
Blade 1500mm	04.300
Blade 1800mm	04.800



## PLASTIC BLADES

The plastic plow blades produced using a rotational molding method are suitable for snow removal and surface planning. The plow blades are made of special cold-resistant plastic that has excellent gliding properties, corrosion resistance and chemical durability.

Working height 580mm

Working width 1520mm

Plastic plows	Code
Plastic blade 1520mm	20.7700



## HIGH-THROW BLADES

High-throw, curved asymmetrical plow blades are designed for faster snow clearing, the top mounted plastic extension prevents snow being thrown over the upper edge and directs it to higher on sideways instead. Perfect tool for snow removal from a roadway.

Working height 410 - 660mm  
Working with 1500mm /1800mm



High-throw blades	Code
High-throw blade 1500mm	20.7200
High-throw blade 1800mm	20.7300



## PUSH BROOM

Push Broom is suitable for the toughest sweeping needs, cleaning agricultural, commercial and industrial debris, rubbish, leaves and even snow, withstanding water and industrial spills. Perfect for maintaining hard surface trails, sidewalks, driveways and sweeping out storage sheds or pole buildings. Push broom is equipped with easily replaceable polypropylene brushes.

Working height 300mm  
Working width 1500mm

Product	Code
Push broom 1500mm	20.1000



# ACCESSORIES FOR PLOWS



## HYDRAULIC CONTROL

Hydraulically controlled turning and lifting / down pushing of the plow allows also the ground soil planning works in addition to the usual snow pushing purpose. Additional information about hydraulic power unit page 94.

Turning	Code
Hydraulic Power Unit	71.0000
Turning cylinder hardware kit	71.2600
Hydraulic cylinder with hoses	71.3100

Lifting	Code
Hydraulic Power Unit	71.0000
Hydraulic cylinder with hoses	71.3100
Model specific lifting cylinder adapter see page 100–108.	

Turning and lifting	Code
Hydraulic Power Unit	71.0000
Turning cylinder hardware kit	71.2600
2 x Hydraulic cylinder with hoses	71.3100
Model specific lifting cylinder adapter see page 107–115.	

Hose extensions (UTV)	Code
Hydraulic hose extensions 3500mm	71.100

- HYDRAULIC POWER UNIT
- MODEL SPECIFIC LIFT CYLINDER ADAPTER
- HYDRAULIC CYLINDER WITH HOSES
- TURNING CYLINDER HARDWARE KIT
- HYDRAULIC CYLINDER WITH HOSES

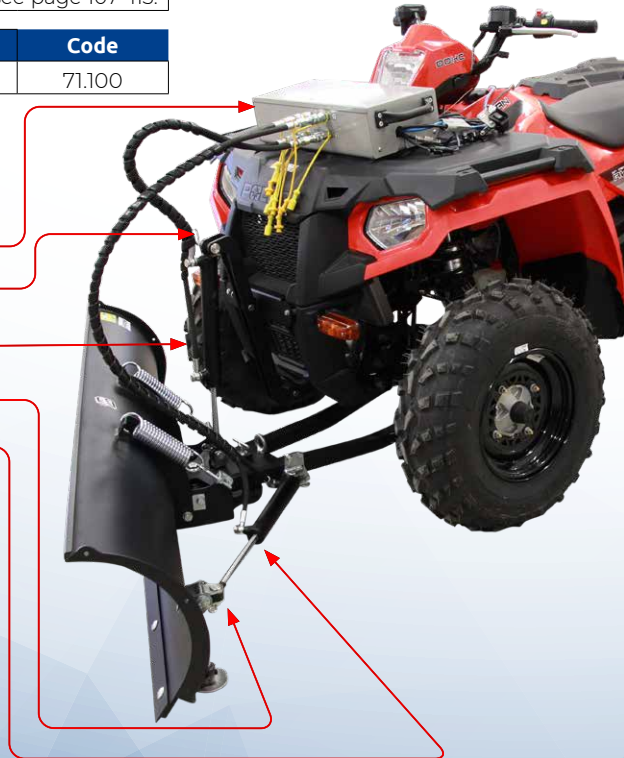



## ELECTRO-HYDRAULIC CONTROL

Electro-hydraulically controlled turning and lifting / down pushing of the plow allows also the ground soil planning works in addition to the usual snow pushing purpose.

Iron Baltic offer electro-hydraulic cylinders by KYB (Japan) and JDR (China), as well as different sets of control panels with power cables. Additional information about electrohydraulic cylinders page 96.



Turning	Code
Cylinder KYB / JDR	70.1000 / 70.500
Turning cylinder hardware kit	71.2600
Cable set (1-cylinder control)	70.2500

Lifting	Code
Cylinder KYB / JDR	70.1000 / 70.500
Cable set (1-cylinder control)	70.2500
Model specific lifting cylinder adapter see page 107-115.	

Turning and lifting	Code
Cylinder KYB / JDR (2tk)	70.1000 / 70.500
Turning cylinder hardware kit	71.2600
Cable set (2-cylinder control)	70.2600
Model specific lifting cylinder adapter see page 107-115	

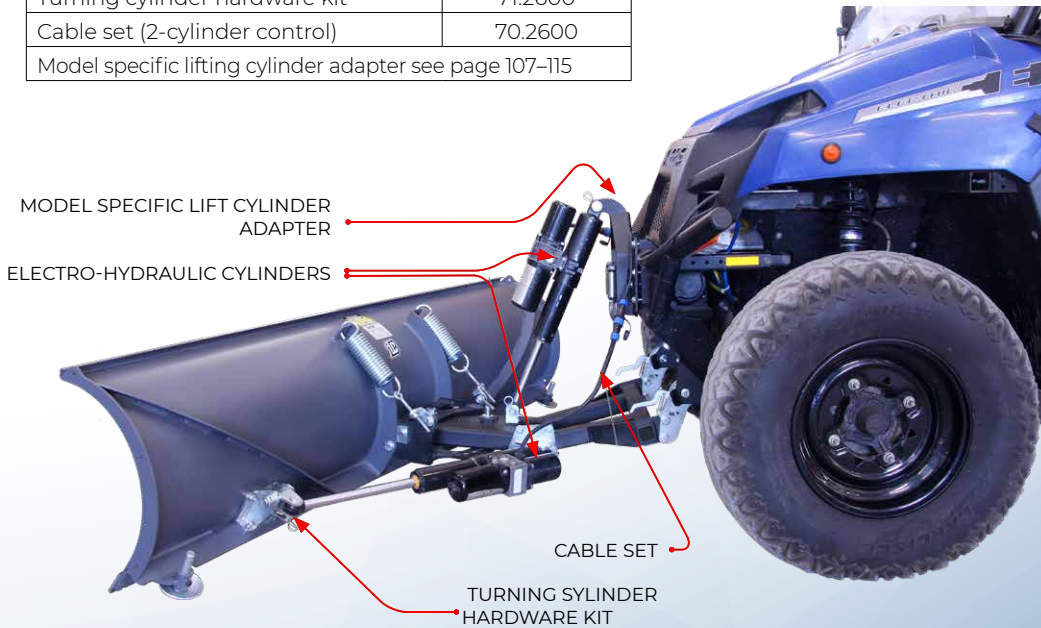

## BUCKET CONVERSION KITS

Suitable for mounting on 1280mm or 1500mm standard plow blades and to complete the kit with front-mount system push tubes. For more information on plow buckets see pages 34–35.

Product	Code
Bucket conversion kit 1280mm	20.6600
Bucket conversion kit 1500mm	20.6650
Mechanical tilt kit	20.6620
Hydraulic tilt kit *	71.10200

\* 71.0000 Hydraulic Power Unit is required for hydraulic tilt assembly.



## RUBBER BLADES

Rubber blades produced from durable 10mm thick sheet polyurethane.

Product	Product compatibility	Kood
Rubber blade 1280mm	04.100	20.6510
Rubber blade 1500mm	04.300 / 20.7200	20.6520
Rubber blade 1520mm	20.7700	20.6560
Rubber blade 1800mm	04.800 / 20.7300	20.6530

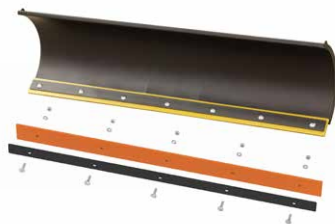

## BLADE EXTENSIONS

Side extensions fitted on standard blades increase working width 150mm.

Product	Code
Blade extensions	04.600VP



**PLOW SIDE MARKERS**

The plastic plow side markers are suitable for mounting on standard blades.

Product	Code
Blade side antenna markers	20.4000



**SNATCH BLOCKS**

Snatch blocks help the plow to be lifted higher and extend the working cycle of the winch cable.

Product	Code
Snatch block	14.10200



**PLOW LIFT STRAP KIT FOR A WINCH**

Lifting strap kit that replaces a winch rope or cable. Ideal for use when working with plows, buckets, or other front mounted devices (when lifting with a winch). The lifting strap has a significantly longer work-life than the wires or ropes originally installed on winches. The set includes a lifting strap and a special large roller strap guide.

Product	Code
Lifting strap with roller	14.11300



# SPARE PARTS FOR PLOWS

Spare parts	Code
Rod kit	20.6270
Rod point, set	20.6275
Latches, pair	20.6280
Latches, pair (heavy-duty, UTV)	20.7450
Locking pin	20.6285
Handler, set	20.6290
Regulators	20.6295
Height adjuster, pair	20.750
Blade 1280mm	20.104
Blade 1500mm	20.806
Blade 1520mm	20.7702
Blade 1800mm	20.2007
Extension spring 7x50x200	OT.11.01.010
Extension spring 8x50x200 (heavy-duty)	OT.11.01.050

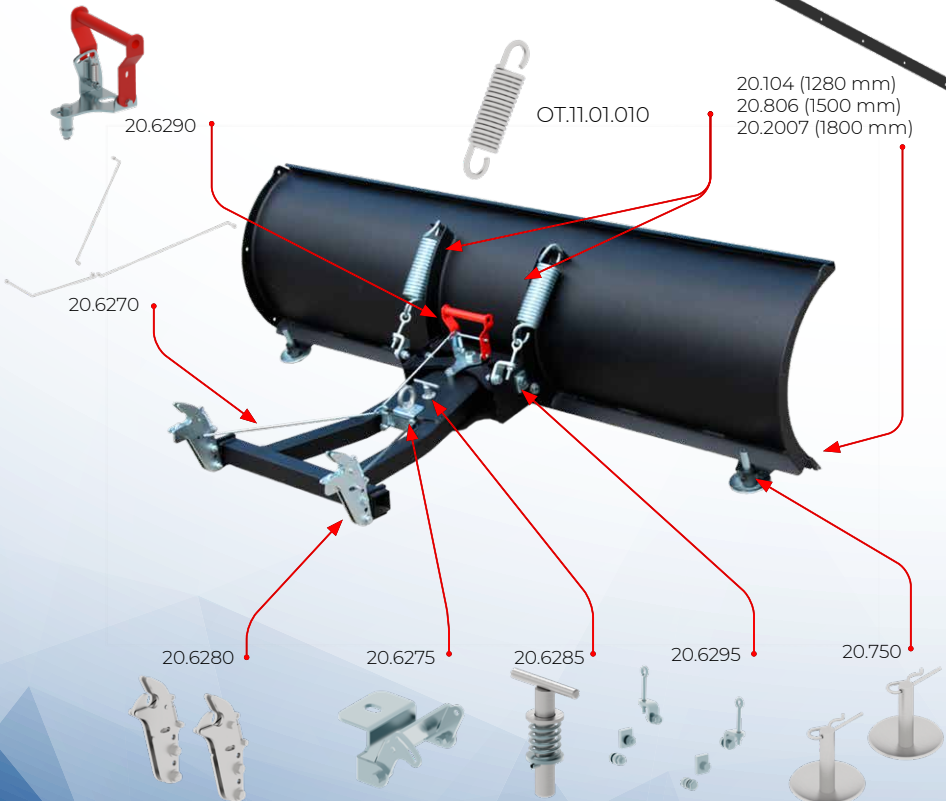
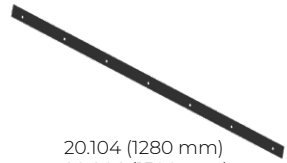
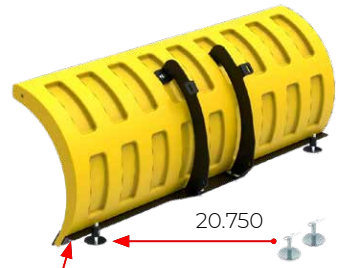



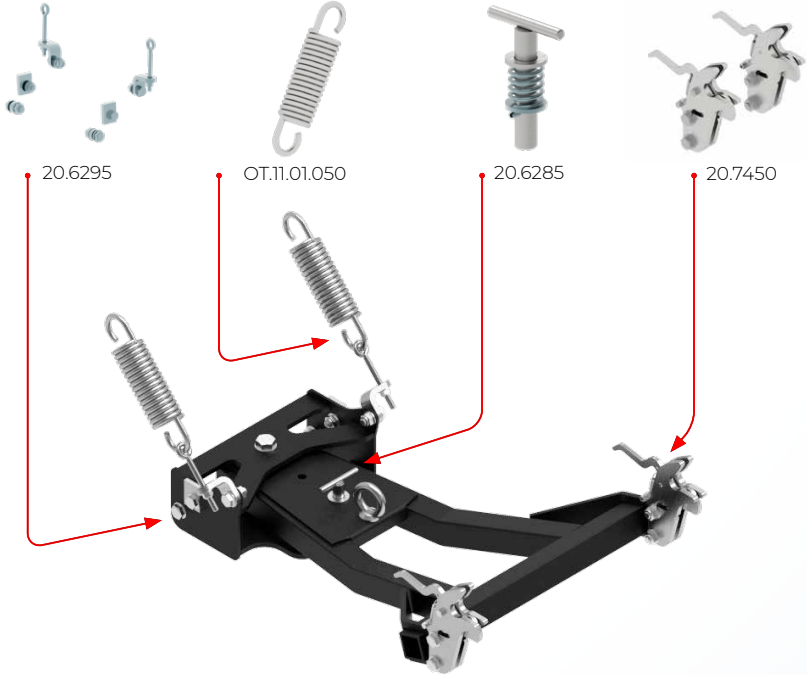



## MID-MOUNT V-PLOW SYSTEM G2



The mid-mount V-plow version is a professional snow removal tool which is mounted bottom of the vehicle using a model specific adapter. The plow has two independently adjustable wings. The steel parts of both wings are equipped with spring-loaded resistor dampers to avoid damage to the plow or vehicle in case of running it into objects on the road. The mid-mount V-plow kit can be assembled with 1500mm or 1800mm wide blades. Optional accessories like rubber extensions, rubber shields, rubber blades or electric / hydraulic plow movement control sets are available additionally.

- Working height 400 - 600mm
- Working width 1500mm / 1800mm
- Different working positions (V position, straight, A position)
- Spring-loaded resistors
- Adjustable working angle
- Sliding shoes for working height adjustment

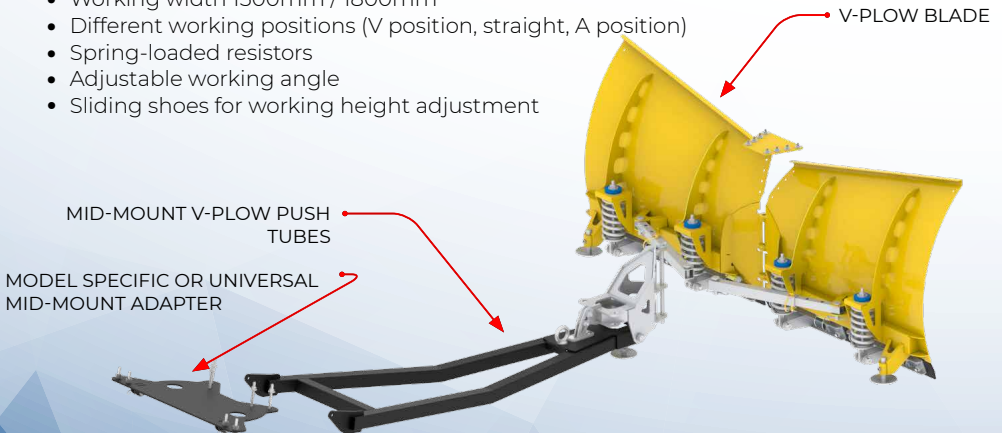

Push tubes	Code
Mid-mount, standard	34.2200
Mid-mount, extended, track fitted / high clearance vehicles.	34.2900
Blades	Code
V-Blade 1500mm	34.3500
V-Blade 1800mm	34.3800
Blades	Code
Universal mid-mount adapter	03.4000
Model specific adapters in the "Mid-mount adapters" table, see page 107-115.	





## FRONT-MOUNT V-PLOW SYSTEM G2



The front-mount V-plow version is a professional snow removal tool. The plow mounts via self-locking, quick attach coupling system to the front of the vehicle using a vehicle model specific mounting adapter. The plow has two independently adjustable wings. The steel parts of both wings are equipped with spring-loaded resistor dampers to avoid damage to the plow or vehicle in case of running it into objects on the road. The front-mounted V-plow can be used with 1500mm wide blades. Optional accessories like rubber extensions, rubber shields, rubber blades or electric / hydraulic plow movement control sets are available additionally.

- Working height 400 - 600mm
- Working width 1500mm
- Self-locking fastening system (quick and easy installation)
- Different working positions (V position, straight, A position)
- Spring-loaded resistors
- Adjustable working angle
- Sliding soles for height adjustment





Push tubes	Code
Front mount, standard	34.3400
Front mount, narrow	34.3600
Blades	Code
V-Blade 1500mm	34.3500
Adapters	Code

Fitment information on model specific adapter and matching push tube version (standard/narrow), find from the table "front mounting adapters" on page 107-115.

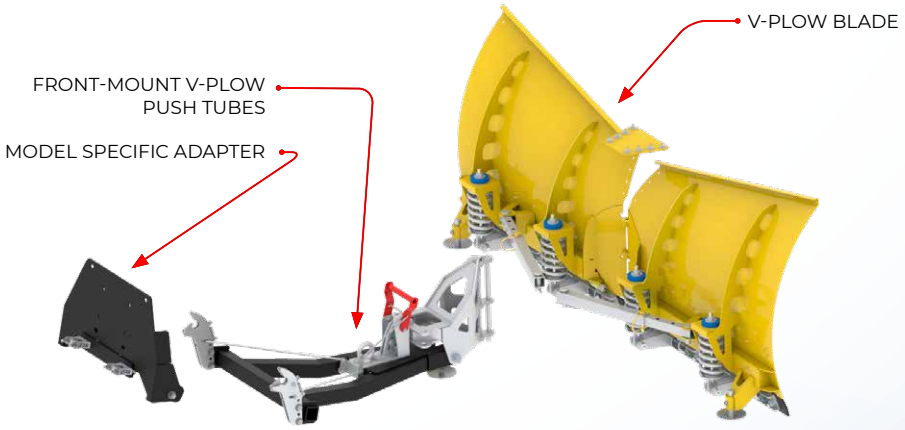

## V-PLOW ACCESSORIES

### HYDRAULIC TURNING

The hydraulic turning kit allows you to adjust the working angles of both wings without leaving the driver's seat. Read more about the hydraulic power unit on page 94–95.

Turning	Code
Hydraulic Power Unit	71.0000
Hydraulic cylinder with hoses G2 V-Plow 1500mm (2 x 71.10000)	71.10000
Hydraulic cylinder with hoses G2 V-Plow 1800mm (2 x 71.3100)	71.3100
Extension hoses (UTV)	Code
Extension hoses 3500mm	71.100

HYDRAULIC  
POWER UNIT

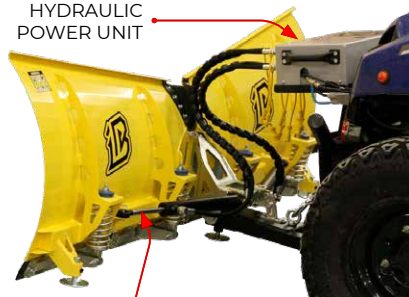

HYDRAULIC CYLINDER WITH HOSES

### RUBBER BLADES

10mm thick rubber blades made of polyurethane (PU) sheet to replace the original steel blades. The rubber blade is double sided. Flip the blade around to other side when one side is worn.

Rubber blades	Code
Rubber blade G2 1500mm	34.3700
Rubber blade G2 1800mm	34.3100

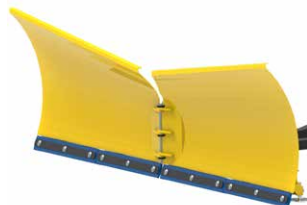

### RUBBER EDGES

Rubber edges made of polyurethane sheet increase working width by 200mm and simplify cleaning of curbs and squares with curbs.

Rubber edges / extensions	Code
Side wings, pair	34.3200



### DEFLECTOR KIT

Deflector kit to prevent snow from throwing over the top edge of the blade.

Deflectors	Code
Deflector kit, set G2 1500mm	34.3900
Deflector kit, set G2 1800mm	34.3300



# V-PLOW SPARE PARTS

Spare part	Code
Blades G2 1500mm	34.3540
Blades G2 1800mm	34.2050
Adjustment tube G2 1500mm	34.3550
Adjustment tube G2 1800mm	34.2040
Blade holder G2 1500mm	34.3425
Blade holder G2 1800mm	34.2550
Sides connector	34.2150
Compression spring	34.2850
Handle	34.3415
Rubber cover	34.3420
Height adjuster, pair	20.750
Rod kit	20.6270
Latches, pair	20.6280

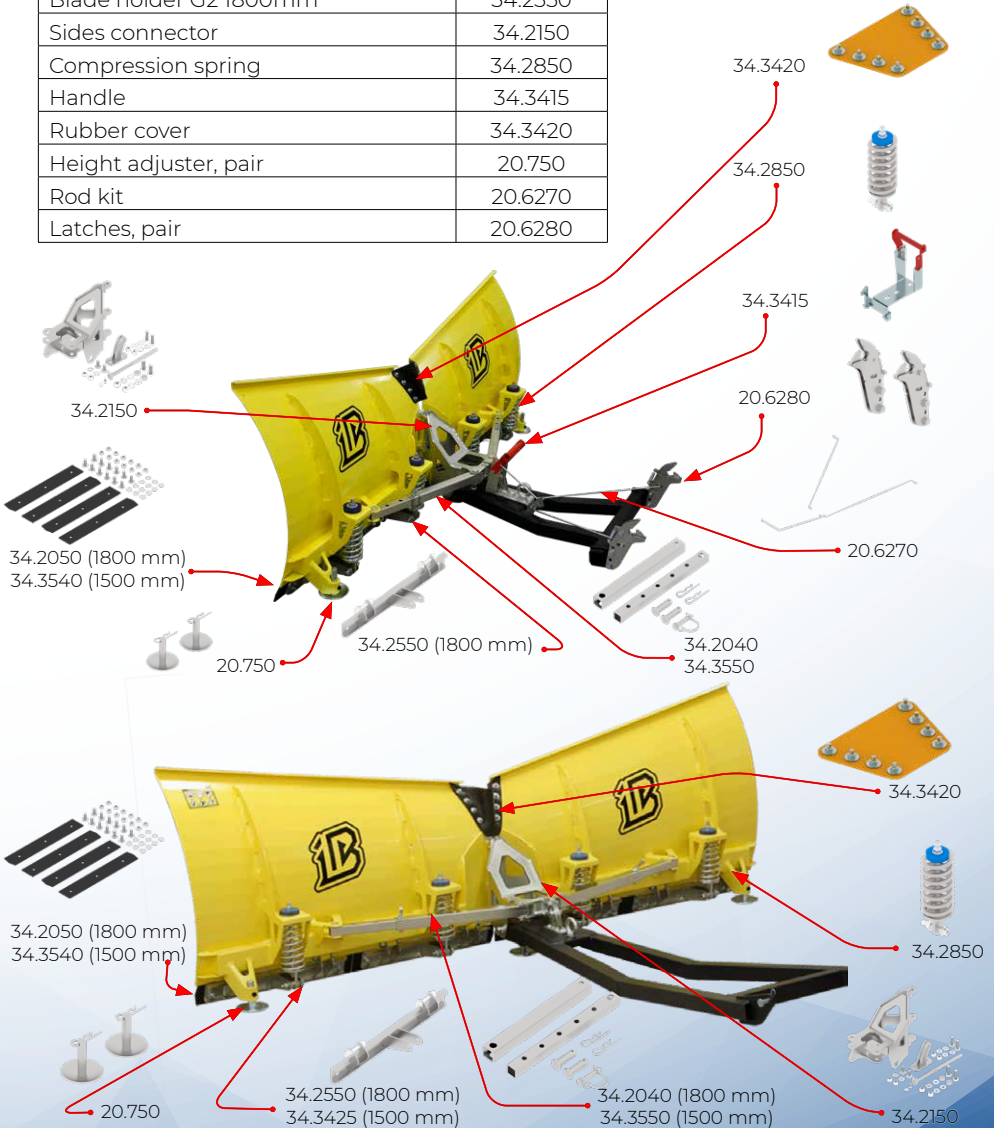



## PLOW BUCKETS



Light material buckets are designed for the removal of snow, sawdust, wood chips, manure, peat and other lightweight materials. The bucket set completes from a front-mounted standard blade with a width of 1280mm or 1500mm (see p. 16–19) and an additional bucket conversion kit which forms the base and sides of the bucket around the plow blade. Dumping / tilting the bucket works with a mechanical dumping release (only bucket 1280 mm) or hydraulically.

- Quick and easy installation
- Automatic bucket return & locking system (mechanical tilt)
- Working width 1280mm / 1500mm
- Capacity 130L / 150L
- Max load 50kg

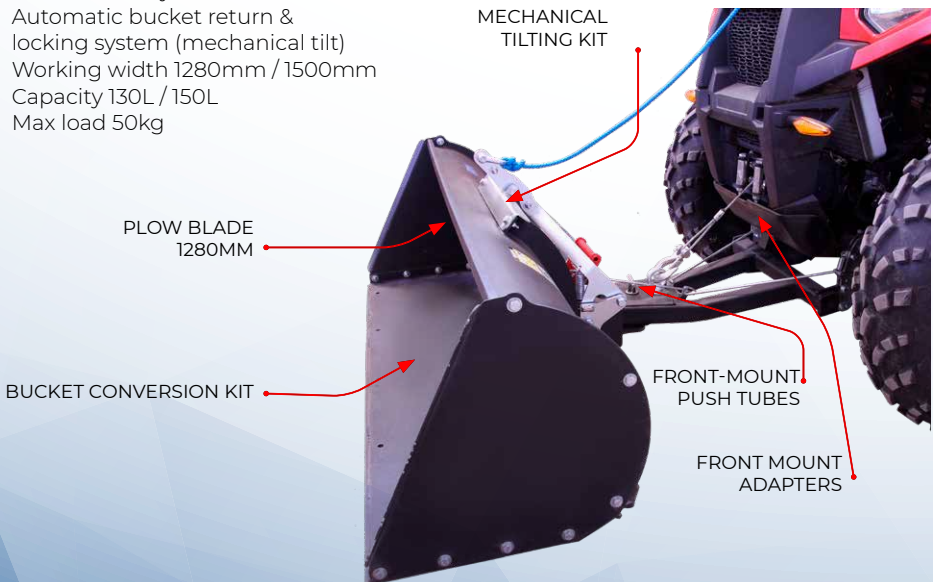



Mechanical bucket 1280mm	Code
Bucket conversion kit 1280mm	20.6600
Mechanical dump / tilting kit	20.6620
Plow blade 1280mm	04.100
Front mount push tubes standard / narrow	20.6200 / 20.6400
Model specific front mount adapters see page 107-115	

Hydraulic bucket 1280mm	Code
Bucket conversion kit 1280mm	20.6600
Plow blade 1280mm	04.100
Front mount push tubes standard / narrow	20.6200 / 20.6400
Model specific front mount adapters see page 107-115	
Hydraulic power unit	71.0000
Hydraulic / dump tilting kit	71.10200
Hydraulic cylinder including hoses	71.3100
Model specific lifting cylinder adapter see page 107-115.	

Hydraulic bucket 1500mm (UTV)	Code
Bucket conversion kit 1500mm	20.6650
Plow blade 1500mm	04.300
UTV front mount push tubes	20.7400
UTV front mount adapters see page 19	
Hydraulic power unit	71.0000
Hydraulic dump / tilting kit	71.10200
Hydraulic cylinder including hoses	71.3100
Model specific lifting cylinder adapter see page 107-115.	

Hydraulic hose extension	Code
Hose extension 3500mm	71.100

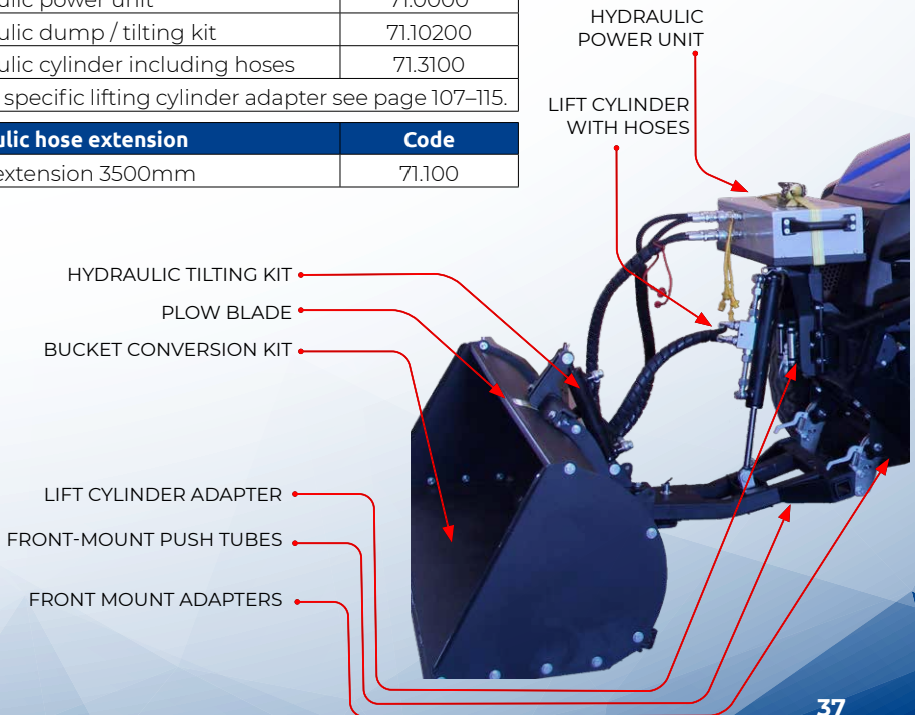



## 2-IN-1 MODULAR PLOW BUCKET

An effective multi-purpose piece of equipment that can be used for cleaning, planing and handling. The modular plow bucket combines a **LOADER** and **PLOW** in one. This means that when the bucket module is removed, the loader becomes a plow suitable for pushing work. The advantage of this equipment is the openable base of the bucket that allows it to be emptied in a raised position. Emptying the bucket can be done by either tilting a lever by the driver's seat or hydraulically with a hydraulic cylinder (among its accessories).

The installation requires a model-based front mounting system adapter attached to the ATV (see adapters on page 107 - 115) and front winch (with a strong wire, rope or lifting strap) that assists the raising and lowering of the bucket.

Use of the equipment with more powerful (over 800 cc) and heavier ATVs or UTVs with a stronger suspension is recommended.

- Bucket working width 1 280 mm
- Bucket capacity 108 litres
- Bucket load capacity 50 kg
- Plow working width 1 280mm (with extenders 1 600 mm)
- Plow working height 360 mm
- Obstacle dampening with springs
- Skid shoes to adjust working height
- Special ball locking, quick coupling pins
- 5 positions of adjustable, plow-working positions
- The working angle and length of the tilting lever are adjustable according to the vehicle



2-1 Modular plow bucket (manual)	Code
2-1 Modular plow bucket	20.7600
Front-mount push tubes	20.6200 / 20.6400
Front-mount adapter see page 107–115	

2-1 MODULAR PLOW BUCKET

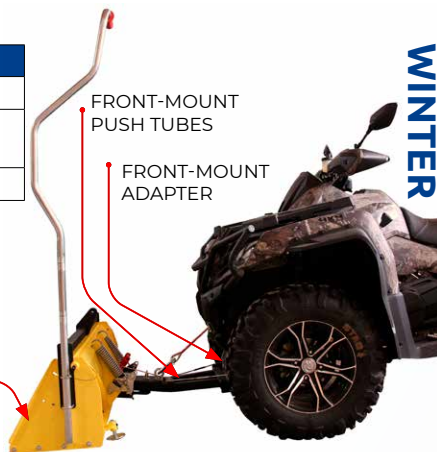

2-1 Modular plow bucket (hydraulic)	Code
2-1 Modular plow bucket	20.7600
Front-mount push tubes	20.6200 / 20.6400
Front-mount adapter see page 107–115	
Hydraulic dump kit	20.7650
Hydraulic power unit	71.0000
Hydraulic cylinder with hoses	71.3100
Front-mount adapter see page 107–115	

HYDRAULIC DUMP KIT  
 2-1 MODULAR PLOW BUCKET  
 FRONT-MOUNT PUSH TUBES  
 FRONT-MOUNT ADAPTER

HYDRAULIC POWER UNIT  
 LIFT CYLINDER ADAPTER  
 HYDRAULIC CYLINDER WITH HOSES



Accessories	Code
Side extensions (2x160mm)	20.7660
Rubber blades 2180mm	20.6510
Plow lift strap kit for a winch	14.11300





## SAND SPREADER G2-500 PRO



The towable, larger, increased capacity G2-500 PRO sand, salt and gravel spreader is a practical and economical piece of equipment suitable for winter maintenance of yards, walking paths and driveways. The spreader shaft is driven by a mechanical transmission from the spreader wheels. The wheels are equipped with clutches that allow driving without spreading, if necessary.

- Working (spread) width 1028mm
- Wheel transmission
- Adjustable spread rate
- Shaft for breaking and mixing bulk material
- For bulk materials (sand, gravel, salt) with a fraction up to 8mm
- Hub locks for adjusting the working and transport position
- Durable 8mm thick natural rubber parts.



Product	Code
Sand spreader G2-500 PRO	52.5000
Accessories	Code
PVC Cover	52.5100
Towing eye 360 degree turning for pin type hitch	22.0505
Spare parts	Code
Rubber band front	52.5029
Rubber band rear	52.5030
Wheel clutch lock	OT.51.01.010





# UNIVERSAL SPREADER / SEEDER

# QUADIVATOR<sup>2</sup>

Universal spreader with simple construction is an effective tool for winter slippery roads control or summer agricultural work. Suitable for spreading sand, salt, seeds, feed, fertilizer and other materials. With the supplied mounting accessories, the spreader can be mounted on the luggage rack of the vehicle or into a 50mm (2") hitch receiver.

- Capacity 57L
- Working width (spread width) up to 9 meters
- Adjustable spread rate
- 12V DC motor, power cable (2,7m) with switch

Product	Code
Universal spreader	52.4000







## ROTARY BROOM



The rotary broom is an efficient tool for removing snow, fallen leaves, sand, debris etc., from roads, streets, walking paths and squares. The broom, that functions with a petrol motor, has a shaft fitted with replaceable polyurethane brush discs which, while rotating, will successfully clean different surfaces. The broom has two supporting wheels which, depending on the work conditions, can be installed in front of, to the sides of or to the rear of the broom. Front mounting the support wheels allows for the easy cleaning of pavement edges, and side mounting assists the brushes in plowing the surface. The supporting wheels also regulate the working height. The work and transport position are adjustable with the front winch of the vehicle. The broom is mounted to the vehicle via model specific mid mount adapter.

Product	Code
Rotary broom 6,5hp (Briggs&Stratton)	48.0000
Rotary broom 4,8hp (Honda GX160)	48.0000A
Accessories	Code
Extended push tube for tracks fitted ATV	04.700S
Spare parts	Code
Brush disk 1pc (broom has total 43 discs)	OT.22.02.010

\* Model specific mid-mount adapter required for installation, see page 107-115.





- Working width 1270mm
- Rotation speed 250-450 rpm
- Replaceable polypropylene bristles (450mm diameter)
- Adjustable working angle in 5 different positions



- Adjustable support wheel position



- Transport and working position adjustable with vehicle winch



- Adjustable working height

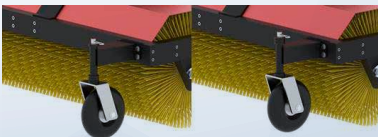



## SNOW BLOWER



A snow blower is the most efficient tool for snow removal. It is possible, with a blower, to move snow many metres away with very little effort, best suited for Nordic and also mountain areas with larger amounts of snow. It is best suited for the winter maintenance of roads and squares.

Iron Baltic snow blowers range vary in between different working widths and engine options. Low powered (13hp/14hp) versions are designed foremost for lighter snow removal works. We recommend using snow blowers with a stronger engine (18hp) for the removal of thicker layers of snow and the wet snow.

The universal adjustable telescope coupling frame allows for the quick and easy attachment of the snow blower to most ATVs or UTVs that have rear ball type hitch fitted. The coupling frame is attached to the rear towing hook and to front suspension arms via tension adjustable chains. The installation time, depending on vehicle and experience could be as less as 5 minutes.

An ATV front winch (min 1500lbs) and towing hook are required for installation!

- Working width 1250mm / 1800mm
- Working height 500mm
- Ejection distance approx. 15 meters
- Electric motor adjustment the ejection tube via on board control panel
- Telescopic mounting frame adjustable to machine length
- Transport position and working position (adjustable with ATV winch)
- Safety bolts to prevent damages from obstructions



**SNOW BLOWER 1250MM (ATV)**

Product	Code
Snow blower 1250mm 14hp (B&S 2100 series) electric starter	30.3000A
Snow blower 1250mm 18hp with electric starter (B&S V-Twin Vanquard)	30.2000A
Accessories	Code
Snow blower extensions (working width +200mm / working height +100mm)	30.100
Spare parts	Code
Safety bolts	30.0001S



**SNOW BLOWER 1800MM (UTV / 6X6)**

Product	Code
Snow blower 1800mm 18hp width electric starter (B&S V-Twin Vanquard)	30.10000A
Accessories	Code
Mounting tube, long (6x6 models)	30.10101
Spare parts	Code
Safety bolts	30.0001S







## SKI TRACK MAKER



The ski track maker is suitable for preparing and maintaining ski tracks. It is suitable for coupling the ATV and UTV (with snow tracks fitted recommended) or snowmobile. It is possible to prepare a 2.3-metre-wide freestyle track by compressing the snow with the ski track maker, a classic style track can be made by fitting an additional classic track setter to the rear of the ski track maker unit.

- Working width 2300mm
- Classic track width 230mm
- 3 positions to fit the classic track setter (sides and center)
- Possible to add ballast weight (sandbags, etc.)  
on classic track setter for more efficient compression of snow
- Easily adjustable ice blade for ski trail maintenance
- Support wheels for transport position. In transport position the device is lifted 200mm above the ground





Product	Code
Ski track maker (includes classic track setter 1pc)	47.0000
Accessories	Code
Classic track setter	47.1000
Spare parts	Code
Middle plastic blade	47.026
Left plastic blade	47.029
Right plastic blade	47.030





## CLASSIC TRACK SETTER



The classic track setter is a simple construction design, reliable product for preparing classic ski tracks. It can be coupled an ATV, UTV, snowmobile or a small tractor. Possible to add ballast weight (sandbags, etc.) on classic track setter for more efficient compression of snow.

- Working width 1100mm
- Classic track width 230mm
- Adjustable tow bar length
- Set includes coupling for a 50mm ball hitch and towing eyelet for a pin type hitch.

Product	Code
Classic track setter	47.2000
Spare parts	Code
Left plastic blade	47.029
Right plastic blade	47.030

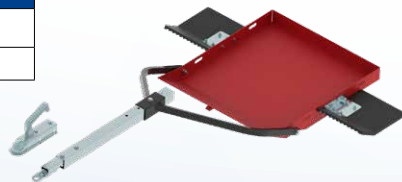



## CARGO SLED



The cargo sled is a well-constructed sled with a large base bed area suitable for transporting large, bulky and heavy loads. The sled is made of 8mm thick PE-HWU plastic, which is light, UV resistant, slippery and durable even at temperatures as low as -50C.

- Length 2900mm
- Width 1200mm
- Height 200mm
- Eyelets for securing the load
- Anti-slip guides
- Set includes coupling for a 50mm ball hitch and towing eyelet for a pin type hitch connection



Product	Code
Cargo sled	22.000

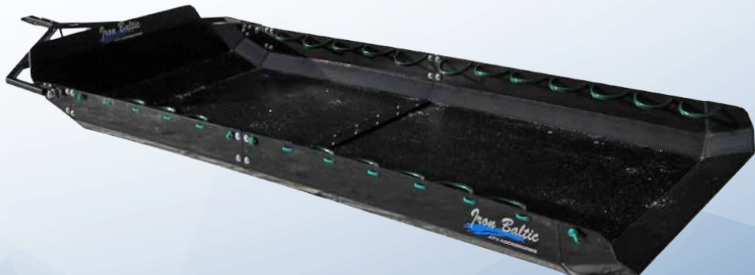



## SKI SLED



An ski sled is a sled intended to use coupled with an ATV, UTV, snowmobile or a small tractor. The sled has a galvanised, powder coated steel construction frame and a humidity-resistant plywood platform ensuring durability even in damp winter conditions. High clearance, special wavy ski profile, plastic sliding surface and spring suspension ensure good pastability and stability. It features removable spacers and platform guards for fastening and transporting different goods.

- Platform dimensions 800 x 2250mm
- Platform height 300mm off the ground
- Ski dimensions 180 x 1750mm (2 skis)
- Galvanized and powder coated steel construction
- Waterproof plywood platform
- Spring shock absorbers on skis
- Plastic ski slides
- Removable struts
- Load restraint guards
- Set includes coupling for a 50mm ball hitch and towing eyelet for a pin type hitch connection



Product	Code
Ski sled	41.0000
Spare parts	Code
Ski kit	41.1000
Shock absorber	41.007





## TIMBER SLED



A sled with skis for transporting logs up to 5 metres. The sled consists of two swivel jointed freight frames with an adjustable gap allowing for the adjustment of the sled length according to the length of the transportable logs. Removable spacers facilitate the loading of the cargo. Suitable for use coupled with an ATV, UTV, snowmobile or small tractor.

- Frame dimensions 750 x 850mm (2 frames)
- Ski dimensions 180 x 1750mm (4 skis)
- Adjustable distance between frames 2500–2900mm
- Suitable for transporting logs up to 5 meters in length
- Galvanized and powder coated steel construction
- Plastic ski slides
- Removable struts
- Set includes coupling for a 50mm ball hitch and towing eyelet for a pin type hitch connection

Product	Code
Timber sled	42.0000







## TRAILER IB-165



The IB-165 Offroad trailer is a platform trailer to use with small tractors and off-road vehicles. The trailer's wide, high clearance off-road style tyres ensure good off-road passage and capability. The tiltable cargo box with completely removable side boards allows the platform trailer to be used for transporting bulk spread or heating materials (e.g. firewood), pallets and boxes etc. Available additionally are gas spring, hydraulic and electro-hydraulic as tilting accessories, and the cargo box board extenders and PVC cover.

### TRAILER IB-165 OFFROAD

Product	Code
Trailer IB-165 OFFROAD	74.1100
Accessories	Code
Swivel hitch	23.1120
Adjustable support leg	61.300
Cargo box extensions (+310mm)	74.2000
Waterproof PVC cover	74.3000
Gas spring	74.4000
Electro-hydraulic lift kit	70.8000

- Load capacity 500kg
- Track width 960mm
- Off-road tires 22x11-8 "60F
- Manual tilting of the cargo box
- Removable front, rear and side hatches
- Moisture resistant plywood bottom platform
- Cargo box dimensions 1197 x 348 x 1605mm
- Tie down anchors for cargo straps





**TRAILER IB-165 EU STREET LEGAL (R1A)**

Product	Code
Trailer IB-165 EU STREET LEGAL (R1A)	74.1000
Accessories	Code
Cargo box extensions (+310mm)	74.2000
Waterproof PVC cover	74.3000
Gas spring	74.4000
Electro-hydraulic lift kit	70.8000

- Load capacity 500kg
- Track width 960mm
- Off-road style tires 22x11-8 "60F
- Swivel hitch coupler
- Adjustable support leg
- Manual tilting of the transport box
- Removable front, rear and side hatches
- Moisture resistant plywood bottom platform
- Cargo box dimensions 1197 x 348 x 1605mm
- Tie down anchors for cargo straps
- Taillights (including turn signals / indicators, stop lights, license plate lights)
- Standard 7-pin connector for powering the trailer lights





## TRAILER OFFROAD 500



Offroad 500 is a simple solidly constructed trailer for household use. The tiltable cargo box allows for the transportation of leaves, soil, firewood, waste etc. After removing the front and rear panels, logs up to 2.5 meters in length can also be successfully transported. Height extenders, PVC covers, and various tilting solutions for the cargo box can be attached as accessories.

- Load capacity 500 kg
- Off-road tires 22x11-8"
- Tiltable cargo box
- Removable front and rear panels
- Removable cargo box height extenders (optional accessory)
- Cargo box dimensions 1 500 x 1 100 x 550 mm

Product	Code
Trailer Offroad 500	89.1000
Accessories	Code
Cargo box extensions (+300mm)	89.2000
Gas spring	89.3000
Electrohydraulic tilt kit	89.4000
Waterproof PVC Cover	89.6000
Adjustable support leg	61.3000







ADJUSTABLE SUPPORT LEG



GAS SPRING



ELECTROHYDRAULIC TILT KIT

WATERPROOF PVC COVER

CARGO BOX EXTENSIONS

TRAILER OFFROAD 500





## TRAILER OFFROAD PRO 1200



Offroad PRO 1200 is a solidly constructed trailer for larger capacity household work. A compact solution, tandem axle and wide terrain tires ensure good terrain passage and allows for access to places that are typically inaccessible with larger gauge equipment. The 1 400 L capacity cargo box with removable height extenders can be used to transport loads up to a weight of 1 200 kg. After removing the front and rear panels, it is possible to also transport logs successfully up to 3 meters in length.

A tilting crane for the cargo box that can be operated with a manual or electrical winch is available as an accessory.

- Load capacity 1 200kg
- Off-road tires 22x11-8"
- 360° swivel hitch coupler
- Adjustable supporting wheel
- Tiltable cargo area
- Removable front and rear panels
- Removable cargo box height extenders (optional accessory)
- Cargo box dimensions 2 000 x 1 100 x 520 mm (820mm)







Product	Code
Trailer Offroad PRO 1200	86.10000
Accessories	Code
Cargo box extensions (+300mm)	86.2500
Lifting Crane	23.4000
Electric winch kit	06.000
Manual winch	OT.13.01.010
Waterproof PVC cover	86.4000

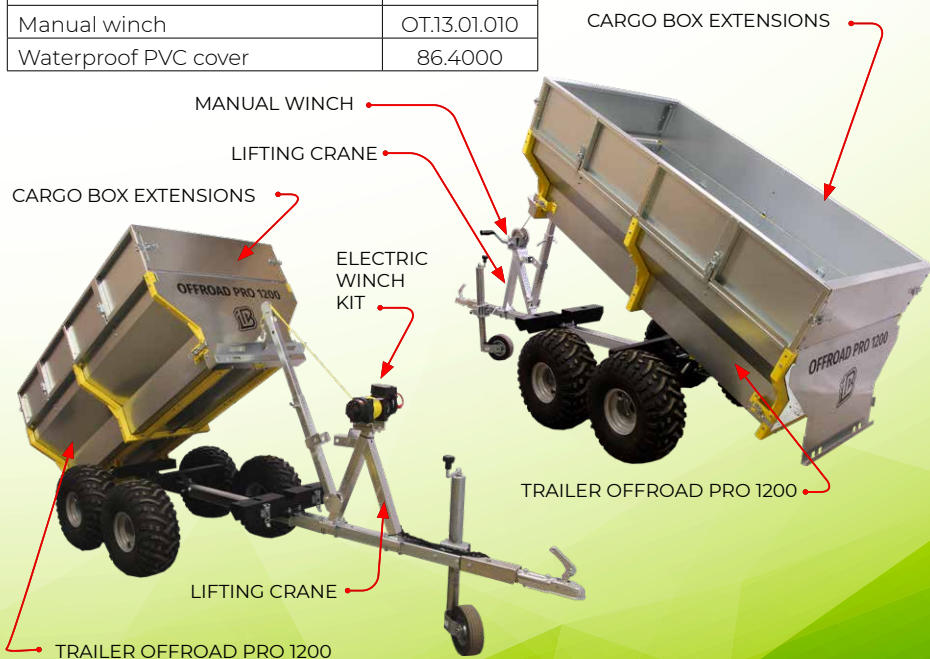



## TRAILER ECO 1500 3-WAY



The ECO 1500 3-WAY tiltable hydraulic trailer is a high-capacity, 1500 kg platform trailer to use with light tractors and off-road vehicles. The high ground clearance of the trailer and the wide all terrain tires ensure good accessibility and off-road capability. The hydraulically three-way tiltable – to back and to left & right side - carrier and removable hatches allow the platform trailer to haul and tilt various materials to a suitable location. The power supply for the tilting hydro-electric power station (supplied) comes from the vehicle's electrical system or from a separate battery (not included) installed to the trailer.

- Load capacity 1500 kg
- Tandem axle with four wheels
- Off-road Tires 22x11-10"
- 360° swivel hitch coupler
- Cargo box is hydraulically tiltable three-way
- Removable side and tailgate
- Cargo box dimensions 2000 x 1300 x 400mm





Product	Code
Trailer ECO 1500 3-way	62.10000
Accessories	Code
Adjustable support leg with a wheel	62.0050
Cargo box extensions	62.1000







## FLAIL MOWER



A sturdily constructed, towable flail mower for mowing large lawns, meadows or roadsides. Mowers with different engine versions are available, depending on expected work conditions. Lower powered 14hp version are foremost meant for mowing smaller areas and shorter grass on regularly maintained fields and areas. We recommend mowers with larger V2 gasoline engines for larger areas, thicker and wilder grass and uneven surfaces. The mowers are fitted with Y-blades intended for mowing / rough cutting the thicker wilder grass by default. Hammer blades are available as an accessory and are suitable for mowing regularly maintained grounds with shorter grass.

- Working width 1150mm
- Cutting height 0-120mm
- Operating speed 2-10 km / h
- Easy to adjust cutting height
- Adjustable working position (behind the vehicle or offside to the sideways)
- Anti scalp rear roller to prevent cutting blades penetrating into ground on uneven surfaces
- Y blades for thicker grass or hammer blades for lawn mowing



Product	Code
Flail mower 14hp (B&S XR2100)	27.4000
Flail mower 18hp (B&S V-Twin Vanquard, HEAVY DUTY)	27.3000
Flail mower 18hp (B&S V-Twin Vanquard with electric starter, HEAVY DUTY)	27.5000



Spare parts	Code
Y blades (Complete set) (56 blades, bolts, nuts, washers, bushes)	27.026
Hammer blades (Complete set) (28 blades, bolts, nuts, washers, bushes)	27.027
Y-blade, 1 pc	27.001
Hammer blade, 1 pc	27.002
Centrifugal clutch 1", set	27.003
Centrifugal clutch 25mm, set	27.003B
Centrifugal clutch 1" HEAVY DUTY	27.003HD
Toothed belt BX41,5 Li1060	27.013A
Belt tensioner wheel, set	27.006
Wheel & Tyre 16,5x6,5, 1pc	27.008
Bearings for rotor UC207 RH/LH with housing, set	27.012
Bearing set for rear roller UC205 with housing, set	27.019
Tension spring, 1pc	27.020
Axle sleeve, 1pc	27.021
Wheel holder, 1pc	27.007
Stone guards, set	27.009
Height adjust handle, set	27.010
Hub cap, 1pc	27.015
Plastic cap (wheel protection tube), 1pc	27.030

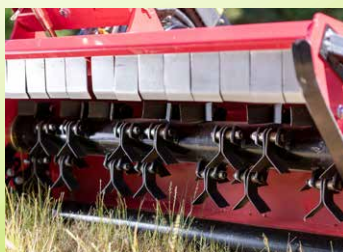





## BALE TRAILER



The compact design of the hay bale trailer and wide off-road tyres ensure good passage, off-road capability, for smaller jobs around the property, allowing the fast and easy transportation of the bales of hay from fields to a storage or direct to animal stables, barns and feeding places. Trailer makes no notable damage to the terrain of fields and is easily maneuverable between trees, over ditches, through narrow or low doorways and in tight indoor spaces allowing access to places outside the reach of larger rigs.

The bale is loaded by backing the trailer to the roll, lowering the spikes using the manual winch, backing the trailer spikes into the roll and using the winch again to lift the bale. Unloading is just as simple and only requires lowering the bale with the winch and driving away.

The trailer can be pulled by all vehicles fitted with a 50mm/2" hitch ball. The trailer can also be pulled by a lawn tractor or other pin connection vehicles when fitted with a coupling eye (22.050S) provided as an accessory.

Product	Code
Bale trailer	43.0000
Accessories	Code
Electric winch package	06.000
Towing eye 360 degree turning for pin type hitch	22.050S





# SILO & HAY BALE TRAILER



Trailer for transporting rolled silage and hay. Strong construction, tandem axle and wide terrain tires ensure a large load capacity and good terrain passage to allow for fast transportation of bales to barns, stables or feeding areas. Loading of the silage bales can be done with the assistance of lifting grips and raised with an electric winch.

- Load capacity 1000 kg
- Maximum bale diameter 1 500mm (60 inches)
- Off-road tires 22x11-8"
- 360° swivel hitch coupler
- Loading/unloading of bales with electric winch (2500 lbs)
- Automatic locking system
- Belt to fasten bales

Product	Code
Silo & Hay bay trailer	85.1000
Accessories	Code
Electric winch package	85.1050
Silo roller strap	OT.37.01.011





## SWEEPER COLLECTOR



Sweeper Collector is an easy to use paddock cleaner, the perfect tool to keep the paddocks free of horse droppings but also great to clean/collect the dead grass, leaves, woodchips or cut grass. Sweeper brushes/bristles have grooming effect on the grass surface, keeping the grass fresh and healthy looking.

The sweeper is powered by an efficient 6.5hp Vanguard engine, rotary broom is fitted with durable OMNILINE polypropylene brushes/bristles, designed to operate in all different kind of cleaning conditions. Large capacity roll-over hopper collects up to 0.75m<sup>3</sup> of material (220kg max load) and is very easy to empty with the aid of the winch, after which the well-balanced hopper returns into a working position automatically itself. Adjustable height spring tines rake helps to pre-loosen and spread the hardened/dry droppings etc. before the collection by the brushes to ensure clean result after.

Working height of the brushes is manually adjustable by default but the electric-hydraulic working height adjuster is also available as an option, allowing comfortable adjustments when operating the tool without leaving the seat. Sweeper/collector tool is an ideal product for private horse owners and small animal farms and zoos, equestrian centers, horse riding schools as well as the public area (parks, city streets, etc.) maintenance and facility management companies.

Sweeper Collector is a tow behind tool that installs to an ATV, UTV or any other vehicle with 50mm (2") ball type hitch fitted, makes the cleaning of large areas like paddocks, parking lots or parks quick and easy.







- Capacity (collector) 0.75m<sup>3</sup> / max 220kg
- Working width 1200mm
- B&S Vanquard 6.5hp engine
- Replaceable OMNILINE polypropylene bristles
- Spring tine rake before the brushes to pre-loosen bigger pieces or hardened material for easier collecting
- Height adjustment with manual lifting mechanism or electro-hydraulic cylinder (optional)

Product	Code
Sweeper collector	78.0000
Accessories	Code
Electro-hydraulic cylinder KYB / JDR	70.1000 / 70.500
Cable kit (1-cylinder control)	70.2500
Spare parts	Code
Brush strip 1200m (1 broom contains 4 brush strips)	OT.22.03.010



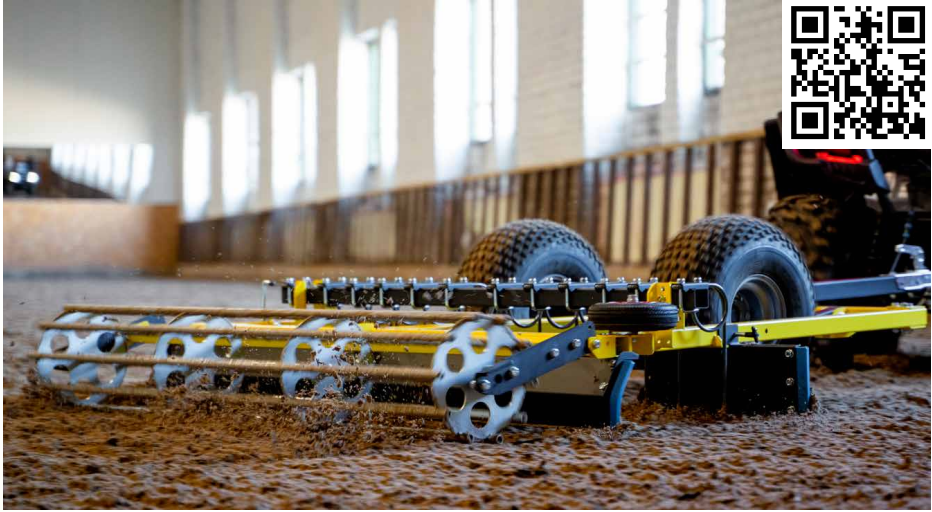

## RIDING ARENA LEVELER



The riding arena plow is intended for leveling and hoeing riding areas. The plow has spring spikes with an adjustable working height for surface hoeing. Adjusting the working angle of the side and rear plow blades allows for the surface at the edges of the riding arena to be shifted back to the middle. There are rubber edges and an adjustable perimeter wheel to protect the walls of a riding arena. The finishing roller compacts the soil, giving it a lovely, polished look.

The riding arena leveller can be towed by all vehicles equipped with a 50 mm/2" ball hitch unit and with a towing eyelet (22. 050S) installed as an optional accessory. The trailer can be also towed by hitching it to other vehicles equipped with a coupling device.

Setting the transportation position and operating depth is done with a manual lifting mechanism or a 12V electrohydraulic cylinder installed as an accessory.





Product	Code
Riding arena leveler	88.1000
Accessories	Code
Towing eye 360 degree turning pin type hitch	22.050S
Electrohydraulic lifting cylinder KYB / JDR	70.1000 / 70.500
Wiring Harness (1 cylinder control)	70.2500

ELECTROHYDRAULIC LIFTING MECHANISM (OPTIONAL)

LARGE SUPPORT WHEELS 22X11-8"

ADJUSTABLE HEIGHT SPRING TINES

ADJUSTABLE HEIGHT LEVELLING PLOW

ADJUSTABLE PERIMETER WHEEL

RUBBER EDGE

ADJUSTABLE ANGLE LEVELLING PLOW

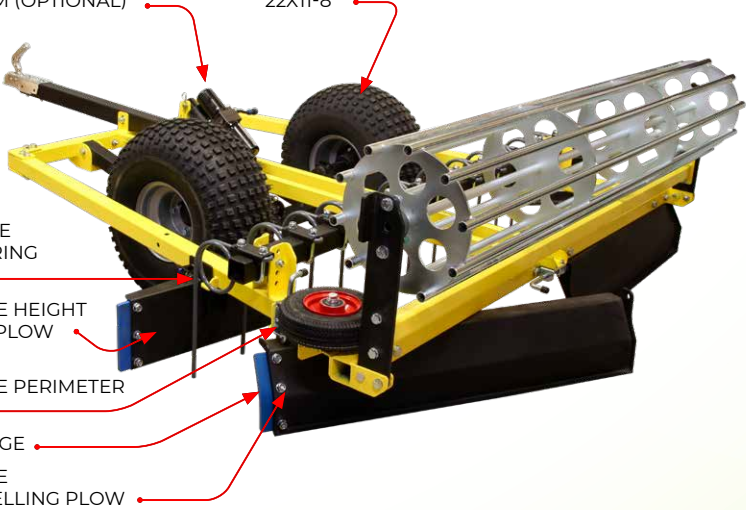

WORKING WIDTH 1800MM

FINISHING ROLLER

MANUAL LIFTING MECHANISM

TOWING COUPLER FOR 50MM / 2" BALL HITCH

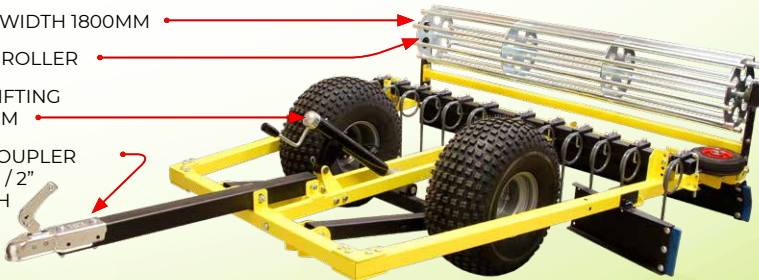



## RECEIVER HITCH SYSTEM



The receiver hitch system is a device mounted into a 2" receiver that different tools can be attached to for soil preparation, cleaning, or landscaping work. Setting the transportation position and work depth is done with a manual lifting mechanism or 12V electrohydraulic cylinder. The receiver hitch system is suitable for use with UTVs or in ATV 2" (50mm) receiver couplings.

Product	Code
Receiver hitch system (manual)	84.1000
Receiver hitch system (electric)	84.1050
Attachment	Code
Disc harrow	84.2000
Rear plow	84.3000
Cultivator	84.4000
Landscape rake	84.5000
Harrow	84.7000
Two bottom plow	84.9000
Single bottom plow	84.10000
Potato digger	84.11000
Push broom	84.12000
Accessories / Parts	Code
Electrohydraulic cylinder KYB (Japan)	70.1000
Electrohydraulic cylinder JDR (China)	70.500
Mounting adapter (middle)	84.9001S
Mounting adapter (side)	84.8001S
Wiring Harness (1 cylinder control)	70.2500

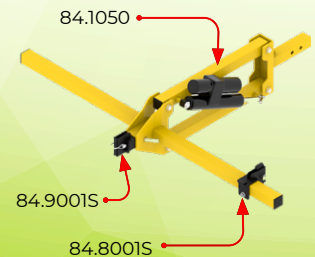
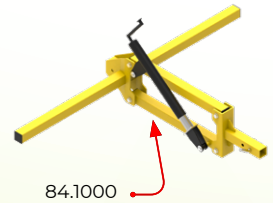

**Disc harrow** to break up hard soil, dry grass and turf, chop weeds or other soil preparation work.

Working width 1 400 mm (adjustable)  
 Spherical discs Ø 365 mm  
 Adjustable disc operating angle from -30° to 30°



**Cultivator** for weed removal or mixing soil prior to planting.

Working width 1 450 mm



**Harrow** for surface planning, soil tilling, smoothing and breaking up larger chunks of soil and readying the surface for seed sowing.

Working width 1 500 mm  
 Working depth 100 mm

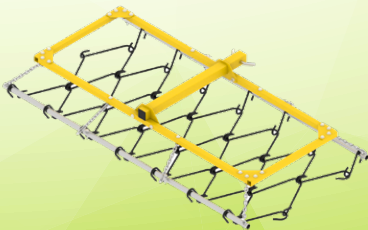

**A single bottom plow** for plowing fields. By using this, soil is rotated to bring fresh nutrients to the surface while simultaneously burying weeds and previous crop residue in preparation for new sowing and planting.



**A two bottom plow or earthing plow** for ridging and earthing work.

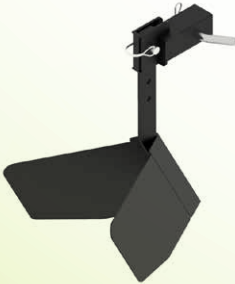

**A potato plow** for digging up potatoes. The potato digging plow has metal rods that the soil passes through while the potatoes remain on the surface.



**Surface rake** for soil preparation work, surface planing or field maintenance/cleaning.

Working width 1 450 mm  
Working height 350 mm

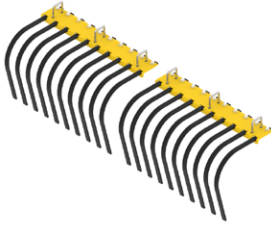

**Rear plow** for surface planing or cleaning waste, leaves, snow etc., from different areas.

Working width 1 450 mm  
Working height 300 mm  
Working angle adjustable from -16° to 16°



**Push broom** to clean driveways, sidewalks, parking areas, squares, warehouses, barns etc., of waste, leaves, snow etc.

Working width 1 500 mm  
Working height 250mm  
Working angle adjustable from -20 ° to 20°







## DRAG HARROW



A harrow for breaking up soil or planning the surface. It is suitable to use with ATV and UTV off-road vehicles, small tractors or lawn tractors. Cutting or smoothing work position according to to which side down the harrow is pulled.

- Working width 1200mm
- Working depth 100mm
- Wire diameter 12mm
- Cutting or smoothing working position

Product	Code
Drag harrow	59.1000





# LEVELER



A leveller is a simple steel net piece of equipment for levelling and planning large areas. It is suitable to use with ATV and UTV off-road vehicles, small tractors or lawn tractors. The leveller is suitable for preparing fields, lawns and prior- or post-processing the soil when seed planting. It is also suited for levelling light gravel and sand beds.

- Working width 1500mm
- Frame for mounting extra weight

Product	Code
Leveler	59.2000

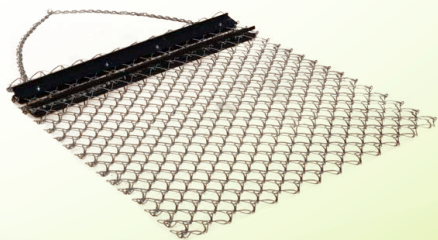





## FLIP OVER DISC



A disc harrow with a simple and strong construction for breaking up turf and weeds, as well as other soil-improving works. The transportation and working position are switched in between by turning the disc cultivator around. It is possible to add extra weight for ballast (sandbags etc.) to improve work effectiveness / cutting depth of the discs. The disc harrow is suitable to use with ATV and UTV off-road vehicles, small tractors or other vehicles fitted with a 50mm / 2" hitch ball.

- Working width 1500mm
- Working angle of 20 degrees
- Cutting depth 150-180mm
- Adjustable drawbar height (3 positions)
- Spherical discs 460mm in diameter (8 discs)



Product	Code
Flip over disc	51.1000





## LANDSCAPE RAKE QUADIVATOR<sup>2</sup>

A landscape rake for tillage and planning the surface. Suitable for planning driveways and parking lots, the maintenance of riding grounds and animal shelters and for raking off the larger stones off the field. The working depth and transporting position is adjusted with a manual lifting mechanism (fitted by default) or a 12V electrical cylinder installed as an optional accessory. Suitable to use with a UTV / side by side vehicles and larger ATV-s, small tractor or other vehicles equipped with a 50mm hitch ball.

- Working width 1800mm
- Tine height 380mm
- Heat treated steel spring tines 380mm high (36pcs)
- 5 pivoting positions to adjust the working angle (-30 / -15 / 0 / 15 / 30)
- Rear mounted wheels have pinned axles allowing 4 different mounting positions on both sides, allowing to adjust the rake offset / diagonally to ground

Product	Code
Landscape rake	69.0000
Accessories	Code
Electro-hydraulic cylinder KYB	70.1000
Electro-hydraulic cylinder JDR	70.500
Cable set (1-cylinder control)	70.2500







## TWO-BOTTOM PLOW QUADIVATOR<sup>INC</sup>

This towable plow with two one-sided blades is a professional agricultural tool for virgin soil or conventional plowing.

The plow has many settings. The position, work height, cutting angle and the drawbar position can be set, depending on the traction unit and plowing conditions. It is possible to set the position of the supporting wheels such that one wheel is in the furrow. It is possible, when plowing virgin soil, to place soil cutting disks in front of the blades and in the case of harder surfaces, it is possible to fix additional weight to the plow to ensure a better plowing result. The setting of the transportation position and work depth is done with a manual lifting mechanism or a 12V electrical cylinder installed as an accessory.

Suitable to use with a UTV / side by side vehicles and larger ATV-s, small tractor or other vehicles equipped with a 50mm hitch ball.

- Plowing width 300mm
- Adjustable furrow depth
- Exchangeable plow blades
- The drawbar position is adjustable according to the height of the traction unit
- The position of the plow is adjustable according to the traction unit track
- The position of the supporting wheels is adjustable for riding in the furrow
- Adjustable soil cutting disk





Product	Code
UTV Two-bottom plow	68.0000
Accessories	Code
Electro-hydraulic cylinder KYB	70.1000
Electro-hydraulic cylinder JDR	70.500
Cable set (1-cylinder control)	70.2500
Weight Kit set 46kg	67.2000







## LAND ROLLER



Field or land roller to roll fields after plowing as well as compact after sowing or leveling work. The field roller mounted on an ATV coupling is an easy to maneuver and sufficiently light tool ideally suited for leveling small and medium-sized fields after plowing without the vehicle sinking into the ground and creating tracks. The roller can be filled with water to add weight to further compact and create a smooth and even surface.

- Working width 1 500 mm
- Roll diameter 475 mm
- Off-road tires 22X11-8"
- 360° swivel hitch coupler
- Weight 150 kg/400 kg (when filled with water)





Product	Code
Land roller	57.2000
Accessories	Code
Support wheels, pair	57.2050







## GRADER / ROAD SCRAPER



A towable road scraper for gravel road levelling and surface planning. Road scraper is equipped with a frame for a 600x800mm pallet on to which a ballast weight can be placed - stones, sandbags etc. The transportation and working height positions are easily adjustable using support wheels. Electric or hydraulic control sets are available as accessories, these allow for the road scraper to be set into the transportation position without leaving the driver's seat.

- Working width 1800mm
- Double-sided toothed blade
- Frame for mounting ballast weight
- Adjusting in between transport and working position via support wheels
- Optional 12V DC electric or hydraulic height adjustment from driver's seat

Product	Code
Grader / Road scraper	44.0000
Spare parts	Code
Blade (steel S355, 10mm)	44.1017
Blade (Hardox 400, 8mm)	44.1017A



**ELECTRO-HYDRAULIC CONTROL**

Further information on electro-hydraulic cylinders see page 88–89.

Electric control	Code
Adjustable towbeam	71.5000
Cylinder KYB / JDR	70.1000 / 70.500
Cable set (1-cylinder control)	70.2500

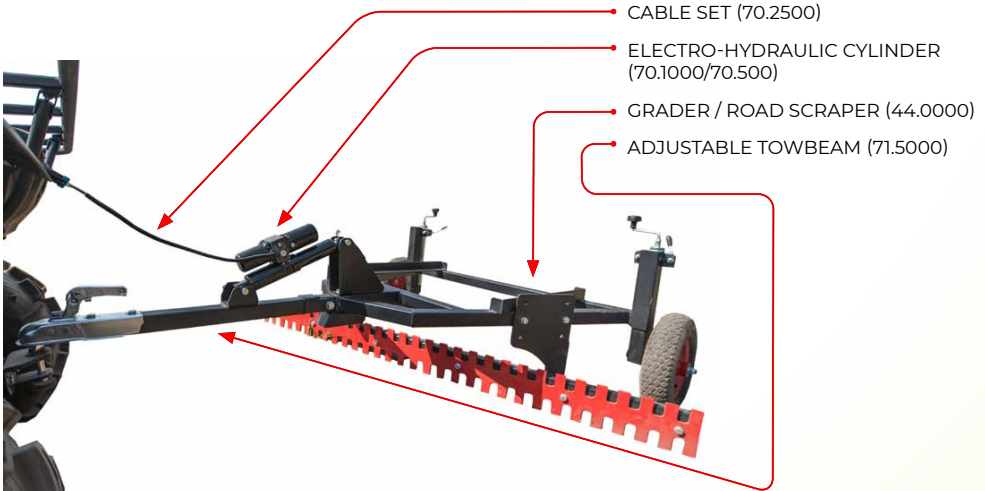

**HYDRAULIC CONTROL**

Further information on Hydraulic power unit see page 86–87.

Hydraulic control	Code
Adjustable towbeam	71.5000
Hydraulic Power Unit	71.0000
Hydraulic cylinder with hoses	71.5100

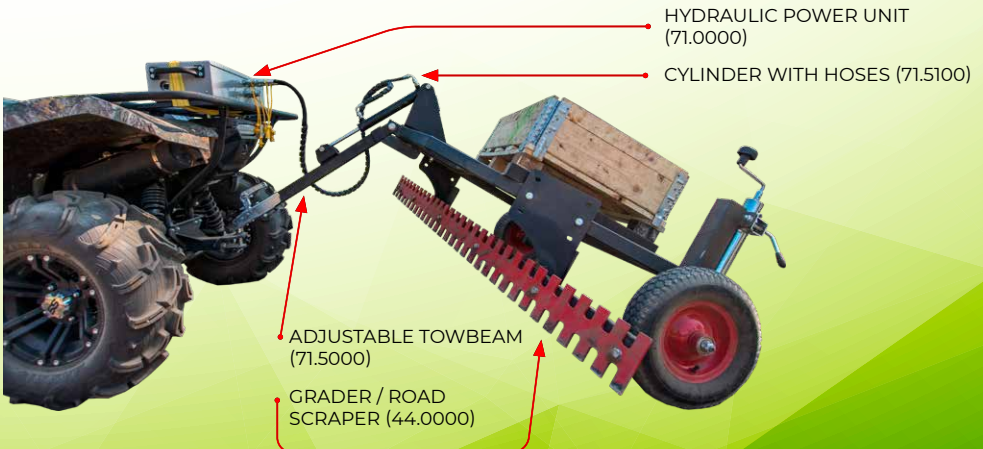



## TIMBER TRAILER IB 1200



IB 1200 is a solidly constructed timber trailer for use with small tractors or off-road vehicles. A compact solution, tandem axle and wide terrain tires ensure good terrain passage, allowing access to places that are typically inaccessible with larger gauge equipment. The adjustable length of the trailer allows logs up to 3 meters long to be transported. The timber trailer has rotatable and easily removable load posts that significantly simplify loading and unloading.

A crane with telescope construction support feet that hold the trailer firmly on the ground can be installed when loading and unloading a larger log to simplify the process. The length and height of the crane boom can be adjusted as required. The IB 1200 uses an electric winch powered by the battery of the vehicle towing it to drag and raise logs.

1400 L cargo box with removable extensions available as an option for the timber trailer. Crane with electric winch for tilting the cargo box.

- Load capacity 1 200 kg
- Crane lifting capacity 300 kg
- Tandem axle with four wheels
- Off-road tires 22x11-8"
- 360° swivel hitch coupler
- Adjustable supporting wheel
- Adjustable trailer length
- Rotatable and removable load posts

Product	Code
Timber trailer IB 1200	86.1000
Accessories	Code
Crane	23.3000
Electric winch kit	06.0000
Lifting tongs / log grapple	23.3070
Additional log bolsters, pair	86.1010S
Accessories box with chainsaw holder	86.3000
Quick release clamps, 1 piece	14.10850
Cargo box	86.2000
Cargo box extensions (+300mm)	86.2500
Waterproof PVC cover	86.4000



TIMBER TRAILER IB 1200

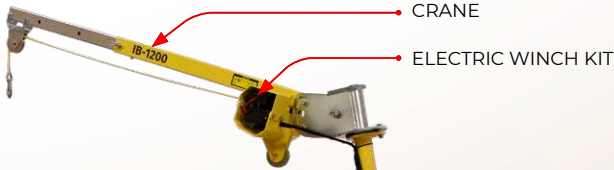

CRANE

ELECTRIC WINCH KIT



TIMBER TRAILER IB 1200



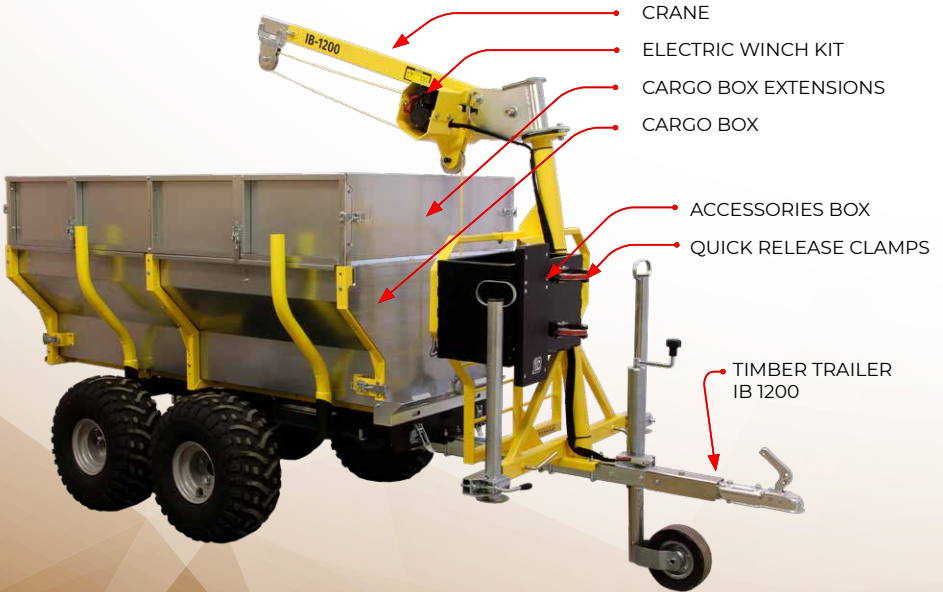
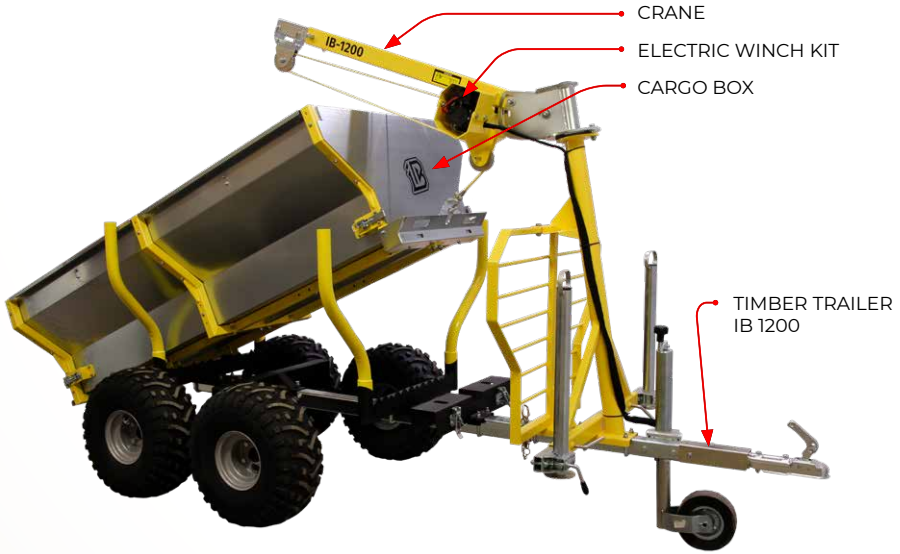



**ELECTRIC WINCH**

Load Capacity 2500lbs (1134kg)  
Rope 6,3mm x 12m



**LOG BOLSTERS**

Additional pair of log bolsters for shorter log transport



**LIFTING TONGS / LOG GRAPPLE**

Lifting tongs for moving logs up to 350mm in diameter



**QUICK RELEASE CLAMPS**

Universal clamps for holding tools up to 50mm in diameter



**ACCESSORIES BOX**

Accessory box with a chain saw holder, mounted on the log guard grille



**PVC COVER**

Weatherproof cover for the cargo box



## TIMBER TRAILER COMBO 1000 **ECO**

A multifunctional trailer for transporting logs, with additional accessories the trailer may also be used as a road scraper, boat trailer, water container or other goods carrier. A tandem axle and wide off-road tyres ensure good off-road passage allowing access to places often not accessible with larger vehicles..

- Load capacity 1000kg
- Tandem axle with four wheels
- Off-road Tires 22x12-8"
- 360° swivel hitch
- Rotatable and removable log bolsters



Product	Code
Timber Trailer COMBO 1000	79.1000
Accessories	Code
Cargo box	39.1000
Crane	79.2000
Electric winch kit	23.3100
Manual winch kit	OT.13.01.010
Boat carrier frame	79.3000
Road grader	79.5000
Water tank carrier frame	38.1000
Water tank 1000L (IBC container)	38.2000
Log support	79.2200
Log grapple / lifting tongs	23.3070
Log Bolsters, an extra pair	79.4000
Accessories box	86.3000
Adjustable support leg	61.3000

**CRANE**

Lifting capacity 150kg  
Boom length 1200 ... 2200mm  
Adjustable boom height  
Adjustable support leg

**CARGO BOX**

Dimensions 1950x1000x550mm  
Removable front and rear hatches

**ROAD GRADER**

Using the crane to adjust transport and working positions.  
Working width 1500mm





**BOAT CARRIER**

Adjustable roller frame for towing a boat up to 4.5 meters. Comes with a hand winch for loading



**WATER TANK CARRIER**

Carrier frame for a standard 1000L IBC container. Spray bar with piping for road watering included

**LOG SUPPORT**

Crane boom-mounted support frame to facilitate log loading





**LOG BOLSTERS**

Additional pair of log bolsters for shorter log transport



**SUPPORT LEG**

Adjustable support leg  
Capacity 300kg

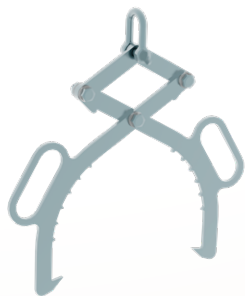

**LIFTING TONGS / LOG GRAPPLE**

Lifting tongs for moving logs up to 350mm in diameter



**ACCESSORIES BOX**

Accessory box with a chain saw holder, mounted on the log guard grille



**HAND WINCH**

Load capacity 725kg  
Steel wire 5mm x 10m



**ELECTRIC WINCH**

Load capacity 1134kg  
Synthetic rope 5mm x 10m



## LOG HAULER



The log hauler hitched to an ATV, UTV or any other kind of off-road vehicle forms a light and compact, easy-to-use transportation solution which can be used for hauling long logs out of the woods. It is easy to manoeuvre between trees and pass through wet areas and ditches with it towed behind the off-road vehicle and haul the logs out from areas where access with larger and heavier vehicles is restricted or would be more difficult.

A wheeled rear support allows to lift the rear end of the log so that it can be transported cleanly, without damaging the forest ground with the dragging log and without further damages to the log itself. The logs can be pulled and lifted clean into the hanging position with the choice of either a manual or electrical winch set.

The log hauler set includes a hanging system for transporting logs with a larger diameter. A rotating carrier frame for smaller logs is available as an additional accessory. The carrier frame is for loading the smaller logs, branches, brush etc.

- Load capacity 500kg (1000kg combined capacity with the rear support used)
- Strong, rigid steel square tube frame 50 x 50 x 3 mm construction.
- Maximum log diameter 50 cm / 20"
- Off-road tires 22x11-8"
- 360 ° swivel hitch
- Hand winch or electric winch option to pull logs out of the forest
- Chains for hanging logs and carabiners for fastening
- Optional rotating carrier frame for transporting smaller logs
- Optional rear support

Product	Code
Log hauler	31.0000
Rear support	31.5000
Accessories	Code
Electric winch kit	31.3000
Manual winch kit	31.4000
Rotating carrier frame	31.6000

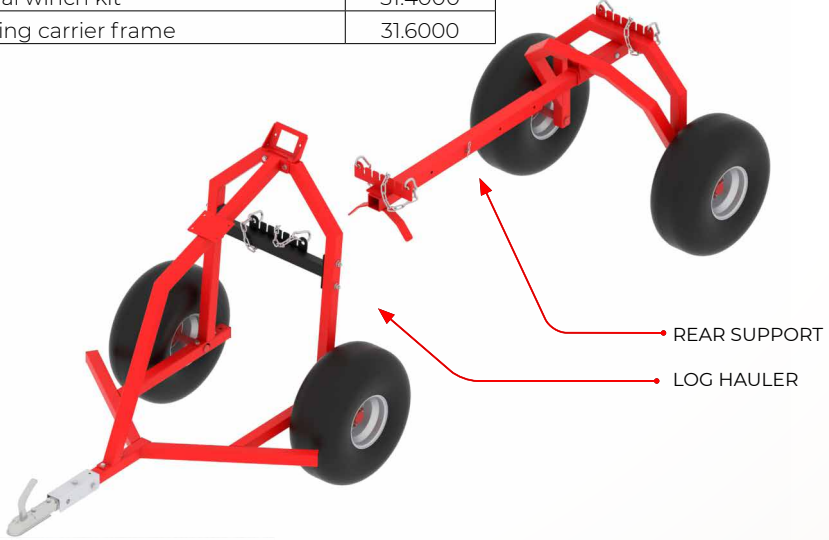

**HAND WINCH**  
 Pull force 725kg  
 Steel wire 5mm x 10m



**ELECTRIC WINCH**  
 Pull force 1134kg  
 Cord 5mm x 10m



**ROTATING CARRIER FRAME**  
 For transporting smaller logs or twigs





## WOOD CHIPPER G1

A wood chipper with a drum cutting method to produce wood chips from branches or smaller diameter trees. This can be used to cover sidewalks as mulch, for heating, etc. The compact size of the chipper ensures that it is easy to maneuver when mounted on an off-road vehicle. It can thus be used in dense or other hard to reach areas without damage to the surface. It is suitable for small-scale forestry work as well as park and real estate maintenance.

- Cutting method — drum
- Productivity 4–6 cbm / h
- Wood max diameter 120mm
- Engine 14hp (B&S 2100 XR Series)
- 360 ° swivel turning ejection tube

Product	Code
Wood chipper G1	76.0000
Spare parts	Code
Belt	76.0001
Clutch kit	76.0002
Cutting blades kit	76.0003





## WOOD CHIPPER G2



With a disc shaft (flywheel) cutting method, this high-yield wood chipper can produce wood chips from branches or smaller diameter trees. The compact size of the chipper, wide track width and the large terrain tires ensure good terrain passage. It is easily maneuvered in dense or other hard to reach areas without damage to the surface.

- Cutting method – disc shaft
- Max. diameter of wood 120 mm
- Motor 14hp (B&S 2100 XR Series)
- 360° rotatable and directable exit spout
- Terrain tires 19x7.00-8'

Product	Code
Wood chipper G2	76.5000
Accessories	Code
Fender & light set	76.5500
Spare parts	Code
Belt	76.5006
Clutch kit	76.0002
Cutting blades kit	76.5002S





## LEAF VACUUM



The leaf vacuum trailer is for personal, domestic use or public, communal service providers to clean and maintain the yards, parks, squares and roads from leaves, to collect grass, litter etc. The equipment allows quick and easy cleaning of large areas by collecting the leaves or mowed grass into the trailer's cargo box and transporting them to the desired location for unloading.

The leaf vacuum is equipped with a reliable 6hp Briggs & Stratton engine that is used to run a durable turbine 4 blade impeller made from Hardox 400 steel, with a productivity of 70m<sup>3</sup>/h. The product is equipped with a suction tube with a diameter of 180mm and a length of 3.5m, with a light and convenient wheeled nozzle.

The product set consists of the BASIC 500 (61.1000) modified trailer and the leaf vacuum module (81.2500) attached to it. The leaf vacuum module (vacuum, load surface grille, PVC cover) is easy to install onto the trailer and can easily be removed for the off-season period so that the trailer may be used for other purposes as well if desired.

- Cargo box capacity 1.2m<sup>3</sup>
- Vacuum productivity 70m<sup>3</sup> / min
- Load capacity 500kg
- Engine 6hp Briggs & Stratton
- Off-road tires 22x11-8"
- Flexible suction tube diameter 180mm / length 3.5m
- Oils and biological acids resistant suction tube materials
- Tilttable cargo box
- Removable PVC cover and hatches
- Adjustable support leg





Product	Code
Leaf Vacuum Trailer	81.2000







## HYDRAULIC POWER UNIT



The compact, electric motor-powered hydraulic unit is for ATV / UTV coupling devices. The hydraulic station has two ¼" quick release hydraulic couplers, to which it is possible to attach cylinders for turning and lifting the snow plow, controlling the bucket or setting the working positions of other coupled equipment. Allows to use the "free floating" option on one cylinder - good to use on a plow up-down movement cylinder. The unit is controlled via a radio remote control which can be mounted to the vehicle's control panel or any other convenient location using the supplied mounting bracket. The electrical power for the equipment to be taken from the electrical system of the vehicle.

- Productivity 2.8 l / min (0.45cm<sup>3</sup> / rev)
- Operating pressure 180 bar
- Motor 800W / 12V DC
- Oil tank 1 liter
- Hydro output 2 x ¼"
- Wireless / remote switch

Product	Code
Hydraulic Power Unit	71.0000
Hydraulic cylinder & hoses sets	Code
Hydraulic hose extensions 3500mm	71.100
Hydraulic cylinder with hoses 250/1400	71.3100
Hydraulic cylinder with hoses 250/1600	71.5100
Hydraulic cylinder with hoses 178/1400	71.10000



**Usage places**

Standard plow turning and lifting, page 22
V-plow turning, page 32
Bucket lifting / tilting, page 34–35
Adjusting the working position of the grader, page 79

**HYDRAULIC CYLINDER WITH HOSES 250/1400**

- Cylinder diameter 32mm
- Mounting size min 380mm
- Cylinder stroke 250mm
- Hose length 1400mm

Mid-mount and front-mount system plow turning.

V-plow G2 1800 Blade turning.

Mid-mount, front-mount and V-plow system plows and buckets lifting / suppressing

**HYDRAULIC CYLINDER WITH HOSES 250/1600**

- Cylinder diameter 32mm
- Mounting size min 380mm
- Cylinder stroke 250mm
- Hose length 1600mm
- Quick connection ¼ "

Adjusting the working and transport position of the grader.

**HYDRAULIC CYLINDER WITH HOSES 178/1400**

- Cylinder diameter 32mm
- Mounting size min 300mm
- Cylinder stroke 178mm
- Hose length 1400mm
- Quick connection ¼ "

V-plow G2 1500 blade turning.

**HYDRAULIC HOSE EXTENSIONS  
3500MM**

- Hoses length 3500mm
- Quick connection ¼ "





## ELECTRO-HYDRAULIC CYLINDER

Compact electro-hydraulic cylinders are intended for exterior use, for setting the work and transport positions of different products. The product can easily be transferred from one piece of equipment to the other. The 12V DC power it requires to operate, taken from the electrical system of the vehicle. The selection includes KYB (Japan) and JDR (China) cylinders as well as different sets of control panels with power cables.

- Pull force 1800lbs (816kg)
- Cylinder rod diameter 20mm
- Mounting eye diameter 16mm
- Mounting gap min 380mm
- Stroke 250mm
- Power supply 12V DC

Product	Code
Electro-hydraulic cylinder KYB	70.1000
Electro-hydraulic cylinder JDR	70.500
Accessories	Code
One cylinder control kit	70.2500
Two cylinder control kit	70.2600
Usage places	
Standard plow turning and lifting, page 22	
Adjusting the working position of the grader, page 79	
Trailer IB-165 cargo box tilting, page 50–51	
Adjusting the working position of Quadivator products, page 73–75	



KYB MMP4-B1B250BB-DHR



JDR FY023-250



**ONE CYLINDER CONTROL KIT**

Control panel set with power cables and mounting devices for controlling one electro-hydraulic cylinder.

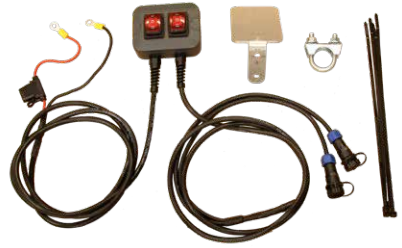

**TWO CYLINDERS CONTROL KIT**

Control panel set with power cables and mounting devices for controlling two electro-hydraulic cylinders.







## HITCH RECEIVER RACK



The hitch receiver rack is an easy to use accessory for transporting trimmers, shovels, rakes or other tools. The product can easily be attached to vehicles with a 50mm / 2" hitch receiver. The rack set includes 2 quick-release clamps that can be used for attaching tools with diameter up to 50mm and weight up to 20kg to the rack. The adjustable height of the rack and 10 different positions for installing the quick release clamps allows transporting the tools with different lengths and shapes. The set additionally includes, attached to the rack, a steel wire basket (468x268x342mm) that can be used for transporting a petrol canister or other similar goods.

Product	Code
Hitch receiver rack	14.10870





# CHAINSAW HOLDER



A universal adjustable chain saw holder that is easy to install and remove. The holder, made from durable plastic, has a socket that fits most sizes of chain saw guide plates and does not damage the chain. The chainsaw holder can be attached to the front or rear rack of an ATV or UTV or to other vehicles equipped with a suitable tubular mounting point using U-clamps. The bolted connection version is ideally suited for attaching to trailer cargo boxes or cases etc.

Product	Code
Chainsaw holder (tubular frame)	14.7000
Chainsaw holder (bolted connection)	14.7200

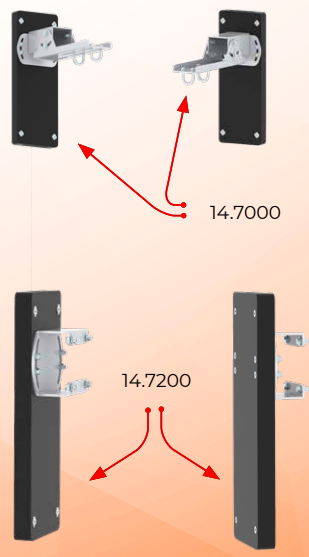
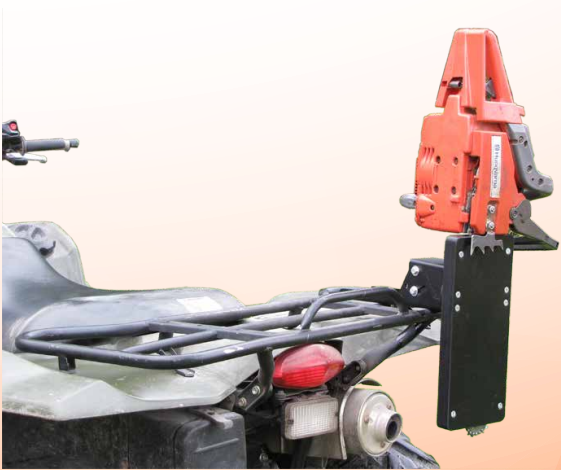



## QUICK RELEASE CLAMPS



Universal quick-release clamps for fastening tools with a diameter up to 50mm. The product selection includes clamps for tubular material racks or versions with an anchor connection for attaching to CFMOTO and POLARIS or any other racks with matching mounting hole diameter and depth.

Product	Code
Quick release clamps (frame connection)	14.10850
Quick release clamps POLARIS (anchor connection 25mm)	14.10860
Quick release clamps CFMOTO / SEGWAY (anchor connection 22mm)	14.11050



### TUBULAR FRAME CONNECTION

For installation on round products up to 26mm in diameter







**TIE DOWN ANCHOR (POLARIS)**

For installation in openings with a diameter of 25 ... 30mm



**ANCHOR MOUNT ( CFMOTO / SEGWAY )**

For installation on luggage racks and cargo boxes of CFMOTO or SEGWAY plastic 'lock&ride' mounting holes.





# ECCENTRIC CLAMP



Eccentric clamps with anchor connection for attaching accessories to POLARIS or CFMOTO luggage racks.

Product	Code
Eccentric clamp POLARIS (anchor connection 25mm)	14.10000
Eccentric clamp CFMOTO / SEGWAY (anchor connection 2mm)	14.11000



## ECCENTRIC CLAMP (POLARIS)

For installation in openings with a diameter of 25 ... 30mm



## ECCENTRIC CLAMP (CFMOTO / SEGWAY)

mounting on CFMOTO plastic lock & ride luggage racks. Mounting hole 22mm

# WINCH ROPE FAIRLEAD



Aluminum alloy winch synthetic rope slider for mounting on winches with a pulling power up to 3500lbs. Mounting hole spacing 124mm. Dimensions 160x55mm

Product	Code
Winch rope fairlead	14.001



# LOADING RAMPS



Aluminium foldable loading ramps  
Load capacity 550kg / pair  
Length 2200mm  
Width 280mm

Product	Code
Loading ramp	01.500

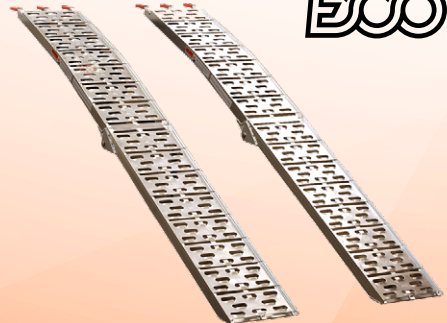

# BED WALL EXTENDERS



Bed wall extenders ensure stability and safety, even in case of higher loads. The front part of the extender has a steel net heightened safety barrier that protects the driver from possibility of shifting loads in the case of sharp braking or accidents.

BRP Can-Am	Code
Bed wall extender Can-Am Outlander 6x6	14.10700
Polaris	Code
Bed wall extender Polaris 6x6 BigBoss 800	14.8000
Bed wall extender Polaris 6x6 BigBoss 570	14.10600



## FRONT PROTECTIONS



The aluminum alloy front cover provides extra protection to the front of the ATV and reduces the impact damages of plastic parts, lights, radiator, etc. in the event of a collision

CFMOTO	Code
CFORCE 850 / 1000	09.800
Kawasaki	Code
KVF 650 Rigid	09.700
KVF 650/750 BruteForce	09.700
Yamaha	Code
550 Grizzly	09.300
700 Grizzly (-2015)	09.300



## CAN-AM G2 RENEGADE LUGGAGE RACK



The luggage rack, constructed for Can-Am Renegade models, consists of a 15mm thick plastic grille with a carrier frame made from strong aluminium alloy. This setup forms a light rack kit that is still extremely durable. The rack is suitable for all Can Am G2 Renegade models and is attached to the ATV using four bolts. It is possible to attach additional accessories, such as the Iron Baltic universal baskets and cases to the rack.

BRP Can-Am	Code
Renegade G2 500/570/800/850	14.1200



# EQUIPMENT BOX



The steel made equipment box with a universal design solution is for installation on POLARIS SPORTSMAN models but is suitable for attaching to front and rear racks of other ATV models as well. The product's separating inner walls have adjustable locations and the bottom is covered with a rubber that prevents slipping. The box is attached to the rack using U-clamps that come with the set or with eccentric clamps that can be ordered as an additional accessory.

The equipment box can be ordered, if desired, together with the universal chainsaw holder. The holder, made from durable plastic, has a socket that fits all sizes of saw chain guide plates.

A PVC cover for the equipment box, which protects the box contents from rain, snow or dirt, is available as an optional accessory.

Product	Code
Equipment box	56.5000
Equipment box with chainsaw holder	56.6000
Accessories	Code
PVC cover	56.5100
Eccentric clamp POLARIS	14.10000
Eccentric clamp CFMOTO / SEGWAY	14.11000





# ACCESSORIES FRONT AND REAR BOXES



Steel net baskets that attach to the front and rear racks provide significant additional space for transporting goods. The plastic (HDPE), a weatherproof box with a lockable lid can be attached to the rear rack. The front basket and cargo box are attached using the U-clamps that are included with the set or using eccentric clamps that can be ordered as an accessory.

Product	Dimensions (mm)	Code
Front basket	920x440x160	56.7100
Cargo box 8050	1000x540x380	56.11000
Accessories		Code
Eccentric clamp POLARIS (anchor connection 25mm)		14.10000
Eccentric clamp CFMOTO / SEGWAY (anchor connection 22mm)		14.11000

## FRONT BASKET



## CARGO BOX 8050



# MODEL SPECIFIC MOUNTING KITS



## FRONT-MOUNT ADAPTERS

Model specific adapters for mounting front-mount system.



## MID-MOUNT ADAPTERS

Model specific adapters for mounting mid-mount system.



## FRONT WINCH MOUNTING KITS

Model specific adapters for „WARN “ or „Bronco“ type of ATV winches with mounting pattern of 76x124mm



## REAR WINCH MOUNTING KITS

Model specific adapters for „WARN “ or „Bronco“ type of ATV winches with mounting pattern of 76x124mm



## HITCH BALL MOUNTING KITS

Model specific reinforced design rear hook adapters. Most kits include a 50 mm hitch ball and a 16mm pin connection.



## LIFT CYLINDER ADAPTERS

Model specific adapters for installing hydraulic and electro-hydraulic cylinders for up-down movement of plows, push brooms and buckets.

## MODEL SPECIFIC MOUNTING KITS

Model	Mid-mount adapter	Front-mount adapter		Front winch mount	Rear winch mount	Hitch-ball mount	Lift cylinder adapter
		standard	narrow				
<b>Access</b>							
AX 600/700/800 U/U/L	03.4400	03.10900			05.9400		
<b>Arctic Cat</b>							
500/550/700	03.4600				05.5100		
550/700 Alterra	03.8000	03.8100			05.7800	15.1400	71.9000
1000 XT	03.4500				05.5100		
TRV 500/550/700/1000 (-2016)	03.4200				05.5100		
TRV 500/550/700/1000 (2017+)	03.4200				05.8000		
<b>BRP Can-Am</b>							
Outlander G1	03.1500			05.800	05.3000	15.300	71.3000
Outlander G2	03.3500	03.6300			05.5000*	15.1900*	71.3000
Outlander G2 L	03.3500	03.9900			05.5000*	15.1900*	71.3000
Outlander X MIR	03.3500	03.6300			05.5000*	15.1900*	71.3000
Outlander 6x6	03.3500	03.6300			05.7500	15.1900*	71.3000
Renegade G1	03.1500			05.1100	05.3000	15.300	
Renegade G2	03.3500			05.4800	05.5000*	15.1900*	
Renegade X MIR	03.3500			05.4800	05.5000*	15.1900*	
Commander (-2014)	03.3800						
Maverick (-2014)	03.4700			05.5600			
Traxter/Defender	03.8700	03.8600			05.7900	15.1900	

\* Original 2" receiver mount required for installation

<b>Ceatek</b>									
500 Gladiator / Quadrifort	03.1600								
500 KingCobra	03.1600				05.4000				
<b>CFMOTO</b>									
500-Z / 500-2A	03.1800	03.6400			05.3600	05.4900	15.800		
CFORCE X5/X6/X5A/X6A	03.1800	03.6400							
CFORCE 450/520	03.6600		03.6500			05.6900			
CFORCE 550/600	03.6600	03.5900				05.6700			
CFORCE 625 / 625 Touring	03.11300		03.11400			05.9600	15.1400	71.10700	
CFORCE 800/820 (X8)	03.3700	03.5900							
CFORCE 850/1000	03.8500	03.8400				05.7700	15.1400	71.10400	
CFORCE 1000 Overland	03.8500	03.8400				05.7700	15.1400	71.3000	
ZFORCE 550 EX (Z5 EX)	03.5200					05.6300	15.1700		
ZFORCE 600 (Z6)	03.2900				05.3700				
ZFORCE 600 EX (Z6 EX)	03.5200				05.3700				
ZFORCE 800 EX (Z8 EX)	03.5200					05.6300	15.1700		
ZFORCE 1000	03.5200					05.6300	15.1700		
ZFORCE 950/1000 Sport	03.11700			03.11800		05.9700	15.1400		
UFORCE 550	03.4100						15.1300		
UFORCE 600	03.12600			03.12700		05.10300	15.1400	71.11100 71.10850	
UFORCE 800	03.4100						15.1300		
UFORCE 1000	03.10000			03.10600		05.9300	15.1400	71.10300 71.7030	
<b>CORVUS</b>									
Terrain DX4+ (-2021)	03.12200			03.12100				71.10800 71.10900	
Terrain DX4+ (2021+)	03.12200			03.13300				71.10850	



Model	Mid-mount adapter	Front-mount adapter		Front winch mount	Rear winch mount	Hitch-ball mount	Lift cylinder adapter
		standard	narrow				
<b>Dinli</b>							
600 Prime	03.2500				05.2500	15.100	
DL 700/702/702L/703/704	03.2500				05.2500	15.100	
<b>GOES</b>							
520	03.1800	03.6800			05.4900	15.800	
525/625	03.1800	03.6800		05.5500	05.3400	05.3400	
725	03.4400						
UTX 520	03.3000						
Cobalt / Iron	03.6600	03.6800			05.7200 (-2019)		
UTX 700	03.3600						
<b>Hisun</b>							
700	03.3600						
Tactic 550/750 2-UP	03.9000	03.8900			05.8200		71.3000
<b>Honda</b>							
TRX 420 FA (-2013)	03.9000			05.5400			
TRX 420 FE/FM (-2013)	03.9000			05.5400		15.1100	
TRX 420 FA/FE/FM (2014+)	03.3200		03.6000	05.6100		15.1100	
TRX 420 FA6 (IRS)	03.3200		03.6000	05.6100	05.6800	15.2000	
TRX 450 ES/S				05.1900			
TRX 500 FA	03.1300			05.600			
TRX 500 FA (IRS)	03.3200		03.6000	05.6100	05.6800	15.2000	
TRX 500 FE (-2011)	03.1300			05.600			

<b>Honda</b>										
TRX 500 FE (2012-2013)								05.4300		
TRX 500 FE (2014+)				03.3200				05.6100		15.1100
TRX 520 FA (IRS) (2019+)				03.3200				05.6100	05.6800	15.2000
TRX 650/680				03.1200	03.7500			05.500	05.3200	05.3200
<b>John Deere</b>										
XUV 590M				03.10400						15.1400
XUV 865				03.10700						
HPX 815E				03.10800						
<b>Kawasaki</b>										
KVF 360				03.2300				05.1800		
KVF 650 Rigid				03.300	03.7600			05.100		
KVF 650/750 BruteForce				03.300	03.7600			05.100	05.2800	05.2800
<b>Keeway ( Leone Mastiff )</b>										
XY 500-S / 500-L				03.1000						
<b>KUBOTA</b>										
RTV-X900				03.10200						
<b>Kymco</b>										
MXU 250/300				03.2600						
MXU 500				03.1120						
MXU 700 (-2019)				03.9400	03.9300				05.8500	71.3000
MXU 700 (2020+)				03.9400	03.12300				05.10100	
UXV 500				03.2700						

Model	Mid-mount adapter	Front-mount adapter		Front winch mount	Rear winch mount	Hitch-ball mount	Lift cylinder adapter
		standard	narrow				
<b>Linhai</b>							
300/400	03.200						
400 IRS	03.2800			05.3500			
500	03.2800		03.10100		05.9200		
550	03.2800			05.5700			
M550 / 550L	03.2800	03.11100		05.9500	05.9200		
600	03.2800						
<b>ODES</b>							
800	03.9100	03.9200			05.8400		71.3000
650/850/1000	03.12800	03.12900			05.10400	15.1400	
<b>Polaris</b>							
ACE 325/570/900	03.5600	03.7100		05.6500		15.1200	
Sportsman 400 (2011+)				05.3900			
Sportsman 450/570/ETX/SP (-2020)	03.5000	03.5700		05.3900	05.5300	15.1200	71.4000 71.6000
Sportsman 500 (-2010)	03.1560			05.1200	05.6000		
Sportsman 500 (2011+)	03.1560			05.3900	05.5300	15.1200	
Sportsman 550	03.1700			05.3100	05.2700	15.1200	
Sportsman 570	03.5000	03.5700		05.3900	05.5300	15.1200	
Sportsman 800 (-2010)	03.1100			05.1200			
Sportsman 800 (2011+)	03.1560			05.3900	05.5300	15.1200	
Sportsman 850 (-2014)	03.1700			05.3100	05.2700	15.1200	
Sportsman 850 (2015+)	03.1700	03.6200		05.3100	05.2700	15.1200	
Sportsman 1000 (-2016)	03.1700	03.6200		05.3100	05.2700	15.1200	

## Polaris

Sportsman 1000 (2017+)	03.1700	03.7700			05.3100	05.2700	15.1200	71.6000
Sportsman 1000 S (2020+)	03.11500	03.11600				05.9800	15.1400	71.6000
Sportsman X2 500	03.2200							
Sportsman X2 800	03.1900							
Sportsman Touring 550	03.1700				05.3100	05.2700	15.1200	
Sportsman Touring 570 / X2 / Nordic LE	03.5400	03.5700				05.5300	15.1200	71.4000 71.6000
Sportsman Touring 850 (-2014)	03.1700				05.3100	05.2700	15.1200	
Sportsman Touring 850 (2015+)	03.1700	03.6200			05.3100	05.2700	15.1200	
Sportsman Touring 1000	03.1700	03.6200			05.3100	05.2700	15.1200	
Scrambler 850/1000 (-2014)	03.1700					05.2700	15.1200	
Scrambler 850/1000 (2015+)	03.1700	03.6200				05.2700	15.1200	
Scrambler 1000 S (2020+)	03.11500				05.9900	05.9800	15.1400	
RZR 570	03.7200	03.7300			05.1700	05.7100	15.3000	
RZR 800 / 800S	03.2100	03.7300			05.1700	05.2400		
RZR 900 XP (-2014)	03.3300		03.7000		05.4400	05.4500		
RZR 1000 XP	03.5500				05.6400		15.1800	
RZR 1000 XP Turbo	03.5500				05.6400		15.1800	
RZR 900S / 1000S	03.5500		03.7900		05.6400		15.1200	71.10500
RZR PRO XP	03.12000					05.10000	15.1400	
Big Boss 570	03.5400	03.5700			05.3900	05.7400 05.9100	15.1200	71.4000 71.6000
Big Boss 800	03.1100				05.3900		15.1200	
Ranger 400/EV	03.3100		03.7000		05.4200	05.4100	15.1400	71.7000
Ranger 570	03.5100		03.7000		05.4200	05.6200	15.1400	71.7000
Ranger 800 6x6			03.7000		05.4200		15.1400	71.7000



Model	Mid-mount adapter	Front-mount adapter		Front winch mount	Rear winch mount	Hitch-ball mount	Lift cylinder adapter
		standard	narrow				
<b>Polaris</b>							
Ranger 800 Crew				03.7000	05.4200	15.1400	71.7000
Ranger 900 XP	03.4800				05.5900	15.1400	71.7000
Ranger 900 Diesel	03.3400			03.7000	05.4200	15.1400	71.7000
Ranger Diesel (-2018)	03.4800				05.5900	15.1400	71.7000
Ranger Diesel (2019+)	03.4800			03.9800	05.5900	15.1400	71.3500
Ranger 1000 (-2020)	03.4800			03.9800	05.5900	15.1400	71.3500
Ranger 1000 (2021+)	03.4800			03.9800	05.5900	15.1400	71.3500
Polaris General 1000	03.7800			03.7900		05.7300	71.3500
<b>Segway</b>							
Snarler AT6	03.12500	03.12400				05.10200	71.11000
<b>SMC</b>							
J-MAX 700 / 700L	03.5800						
MBX 700	03.5800						
<b>Suzuki</b>							
Eiger 400	03.200				05.1600		
KingQuad 450/500/700/750 (-2018)	03.200	03.6100			05.300	15.200	71.3000
KingQuad 500/750AXi (EPS)	03.200	03.6100			05.300	15.200	71.3000
KingQuad 500/750AXi (2019+)	03.200	03.6100			05.8900	15.1400	71.10100

<b>STELS</b>									
Guepard 850	03.4000	03.11900				03.8600	15.1400		
<b>SYM</b>									
600	03.1110				05.900				
<b>TGB</b>									
425 Blade	03.2400								
550 Blade	03.2400	03.8300			05.6600		15.1400		
600 Blade	03.2400	03.8300				05.7600	15.1400		71.3000
600 LT Blade	03.2400	03.8300				05.7600	15.1400		71.3000
600 LTX Blade	03.2400	03.11000				05.7600	15.1400		
1000 Blade	03.8200	03.8300				05.7600	15.1400		71.3000
1000 LTX Blade	03.8200	03.11000				05.7600	15.1400		
<b>Trapper</b>									
550/750	03.9000	03.8900				05.8200			71.3000
<b>Yamaha</b>									
Grizzly 450 (2006-2008)	03.2000					05.1400			
Grizzly 450 (2009-2010)	03.600					05.1400			
Grizzly 550	03.600	03.7400				05.200	15.1500		71.3000
Grizzly 660	03.600					05.1300			71.3000
Grizzly 700 (-2013)	03.600	03.7400				05.200	15.1500		71.3000
Grizzly 700 (2014-2015)	03.11200	03.7400				05.200	15.1500		71.3000
Grizzly 700 (2016+)	03.11200	03.6900				05.7000	15.1500 15.2100		71.3000
Kodiak 450 (2017+)	03.11200	03.8800	03.8800			05.8100	15.2200		71.3000
Kodiak 700	03.11200	03.6900				05.7000	15.1500 15.2100		71.3000
Rhino 700	03.700								
Wolverine 700	03.9600					05.8700	05.8800	15.1400	71.3600

**ALUMINIUM & PLASTIC SKID PLATES**



**UTV FRONT-MOUNT PLOW HIGH-**



**MID-MOUNT V-PLOW SYSTEM**



**MID-MOUNT PLOW SYSTEM**



**THROW PLOW SYSTEM**



**FRONT-MOUNT V-PLOW SYSTEM GEN2**



**FRONT-MOUNT PLOW SYSTEM**



**PUSH BROOM**



**PLOW BUCKET**





**HYDRAULIC PLOW BUCKET**



**2 IN 1 MODULAR PLOW BUCKET**



**2 IN 1 MODULAR PLOW BUCKET**



**2 IN 1 MODULAR PLOW BUCKET**



**SAND & GRAVEL SPREADER G2-500 PRO**



**UNIVERSAL SPREADER / SEEDER**



**ROTARY BROOM**



**SNOW BLOWER**



**SKI TRACK MAKER**



**CLASSIC TRACK SETTER**



**CARGOSLED**



**SKI SLED**





**TRAILER OFFROAD PRO 1200**



**HAY BALE TRAILER**



**TRAILER ECO 1500 3-WAY**



**SILO & HAY BALE TRAILER**



**FLAIL MOWER**



**SWEEPER COLLECTOR**



**HAY BALE TRAILER**



**SILO & HAY BALE TRAILER**



**SWEEPER COLLECTOR**



**RIDING ARENA LEVELER**



**RECEIVER HITCH SYSTEM**



**RECEIVER MOUNT DISC HARROW**





RECEIVER MOUNT HARROW



RECEIVER MOUNT CULTIVATOR



RECEIVER MOUNT SINGLE-BOTTOM



RECEIVER MOUNT TWO-BOTTOM PLOW



RECEIVER MOUNT POTATO PLOW



RECEIVER MOUNT PUSH BROOM



RECEIVER MOUNT LANDSCAPE RAKE



RECEIVER MOUNT REAR PLOW



FLIP OVER DISC



LANDSCAPE RAKE QUADAVATOR



TWO-BOTTOM PLOW



LAND ROLLER





**GRADER / ROAD SCRAPER**



**LOG HAULER**



**TIMBER TRAILER IB 1200**



**WOOD CHIPPER G1**



**TIMBER TRAILER COMBO**



**WOOD CHIPPER G2**

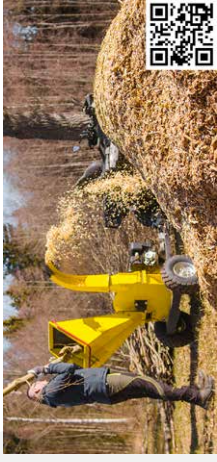

**WOOD CHIPPER G2 ROAD LEGAL**



**LEAF VACUUM**



**HYDRAULIC POWER UNIT**



**MINI MOTION PACKETS**



**HITCH RECEIVER RACK**



**CHAINSAW HOLDER**









[WWW.IRONBALTIC.COM](http://WWW.IRONBALTIC.COM)



## IRON BALTIC OÜ

Põldmäe tee 1  
Vatsla 76915  
ESTONIA

Phone: +372 653 3711  
[sales@ironbaltic.com](mailto:sales@ironbaltic.com)